

**CATALOGUE OF TECHNICAL SPECIFICATIONS  
APPLICABLE TO OUTDOOR LIGHTING INSTALLATIONS SUBJECT TO  
THE REGULATIONS OF LAW 31/1988 ON THE PROTECTION OF THE  
ASTRONOMICAL QUALITY OF THE OBSERVATORIES OF THE  
INSTITUTE OF ASTROPHYSICS OF THE CANARY ISLANDS**

REFERENCE REGULATIONS:

In application of article 6.2 of the Regulations of Law 31/1988, of 31 October, on the Protection of the Astronomical Quality of the Observatories of the Instituto de Astrofísica de Canarias, approved by Royal Decree 243/1992, of 13 March and amended by Royal Decree 580/2017, of 12 June, the Catalogue of Technical Specifications Applicable to Outdoor Lighting Installations subject to the Regulation of Law 31/1988 has been drawn up.

In general, the Energy Efficiency Regulations for Outdoor Lighting installations (R.D. 1890/2008, of 14 November), together with the Low Voltage Electrotechnical Regulations (R.D. 842/2002, of 2 August), regulate outdoor lighting installations in their entirety. All this without prejudice to the adjustment to the requirements for the components of such installations established by the regulations and standards that develop Directive 2009/125/EC. In this sense, and in the territorial scope affected by the actions of the Instituto de Astrofísica de Canarias (IAC), the complementary technical specifications determined in the specific regulatory framework that regulates it and especially the aforementioned Regulation implementing Law 31/1988 must also be taken into account.

Likewise, in accordance with the opinion of the State Attorney's Office, in relation to article 31 of RD.243/92, sanctioning regime, the regulation that generally regulates outdoor lighting is Royal Decree 1890/2008 approving the Regulation on Energy Efficiency in Outdoor Lighting Installations.

Other standards not included in the previous ones that set lighting levels are also applicable, such as RD 314/206 section SUA 4.1 in the portals and accesses to buildings up to the safe area.

The most commonly used standards, with regard to setting lighting levels, are included in Royal Decree 1890/2008, the most commonly used being UNE EN-13201, UNE EN-12193 and UNE EN-12464-2. On the IAC website [www.iac.es/otpc/documentos](http://www.iac.es/otpc/documentos) you can download a document with the compilation of the most used standards and recommendations "Summary of Recommendations for installations open to the outside or outdoor lighting" and in annex "D" of this catalog you have a summary table with the most used "PRACTICAL GUIDE TO LIGHTING LEVELS ACCORDING TO EN-13201 AND RD 1890/08".

The most widely used recommendations at the European level are those of the International Committee on Illumination (IEC), which are also used as a reference in the development of previous standards.

## OBJECTIVE OF THE CATALOGUE:

The primary objective of this catalogue is to ensure that "all outdoor lighting must avoid the emission of light above the horizon and must be carried out in a way and with lamps that produce the minimum disturbance of astronomical observations."

In order to control and evaluate polluting activities that could hinder the research work of the Instituto de Astrofísica de Canarias, to ensure compliance with Law 31/1988, of 31 October, and subsequent application of its Regulations, the Technical Office for the Protection of Sky Quality (OTPC) was created in January 1992 within its structure.

Since its creation, this Office has been developing procedures and different technical guides to provide solutions to the casuistry derived from the outdoor lighting projects and installations carried out at that time in the territorial scope of application of the protection regime established in Law 31/1988, of 31 October, and in its Regulations, evidencing the need for its permanent updating in order to incorporate new solutions and technologies in lighting, and thus facilitate the application of this legislation to the interested parties.

In order to enable the design of such outdoor lighting projects and the control over them by the Technical Office for the Protection of Sky Quality, luminaires and lamps are subject to prior certification by the Technical Office, and outdoor lighting installations to the prior and mandatory report of the Instituto de Astrofísica de Canarias in accordance with Article 5 of Law 31/1988, October 31st, and with Articles 27 and 28 of its Regulations, to validate those characteristics that affect the application of the regulations and the guarantees of protection that constitute their object.

In order to achieve these objectives and for the purposes of issuing the mandatory report referred to in Article 5 of Law 31/1988, October 31st, in accordance with Article 6.2 of its Regulations, the Instituto de Astrofísica de Canarias will have to determine, following a mandatory report from the Government of the Canary Islands, a catalogue of specifications that guarantees the technical validity of the limitations and requirements established in the legislation. thereby providing transparency to the actions of the aforementioned Institute and legal certainty to the interested parties.

This catalogue of specifications has been submitted to the Ministry of Employment, Industry and Commerce for a prior favorable report by the Directorate General of Industry and Energy of the Government of the Autonomous Community of the Canary Islands on 7 August 2017 with exit registration N. 414422/2017.

## STRUCTURE OF THE CATALOGUE:

The Catalogue is organized into four blocks:

The first with the letter "G" refers to general concepts, glossary and definitions.

The letters "T" and "P" define the specifications for installations in Tenerife and La Palma, respectively, being installations with the greatest impact due to their extension on the islands and their normally permanent use throughout the night. In turn, it is divided into "1" motorized road lighting, parking lots, large areas and security, and "2" pedestrian lighting. The difference between islands is due to the fact that the protected object is the ORM in La Palma and the influence of the impact of light depends on the distance to the protected object, which is why La Palma has more restrictive criteria than Tenerife in this type of permanent lighting.

The catalogue continues in a third block with the letter "C" with common criteria for both islands as they are sporadic or temporary installations or with limited lighting until 24 hours, and where lighting needs generally do not allow differentiation of their location (except for ornamental lighting and illuminated advertisements).

Fourthly, a set of annexes is presented: "A" with special specifications for pedestrian lighting or beaconing (bollards) of low power and height for urban pedestrian areas, "B", "C" and "D" aids for the drafting of studies and projects and finally "E" the classification of sanctions or deficiencies.

## **San Cristóbal de La Laguna, August 14, 2017**

(Correction of errata and update of technical report procedures by electronic office on 21-2-2018)

(Update annex A, surroundings of buildings with activity open to the public on 20-7-2018)

(Clarification calculation of utility (utilance) on roads with parking lots, section G-7, on 12-14-2018)

(Clarification on specific brightness levels and LED screens, section C-2, on 05-05-2022)

(Clarification on limitation of blue emissions with peak <440nm, in LED lamps of 2700°K or less, on 13-09-2024).

(Clarification on singular spectral radiance limitation <500nm, in amber LED with filter, on 06-18-2026.)



# INDEX

## GENERAL

G-0) SCOPE OF APPLICATION: .....	6
G-1) BASIC CRITERIA: .....	6
G-2) CERTIFIED LUMINAIRES AND LAMPS. General notes on its use. ....	7
G-3) ABBREVIATIONS/Glossary: .....	7
G-4) HIGH SENSITIVITY ZONE: .....	8
G-5) SCREENED URBAN AREA: .....	8
G-6) PROHIBITIONS, SHUTDOWNS AND FLOW REDUCTIONS: .....	8
G-7) LIGHTING LEVELS AND UTILITY (UTILANCE) CALCULATION: .....	10
G-8) USE AND EQUIVALENCES OF LEDS: .....	11
G-9) IAC TECHNICAL REPORTS: .....	13

## ISLAND OF TENERIFE

T-1) STREET LIGHTING, CAR PARKS, LARGE AREAS AND SECURITY: .....	15
T-2) PEDESTRIAN STREET LIGHTING IN PROMENADES, SQUARES AND GARDENS. ....	16

## ISLAND OF LA PALMA

P-1) STREET LIGHTING, CAR PARKS, LARGE AREAS AND SECURITY: .....	18
P-2) PEDESTRIAN STREET LIGHTING IN PROMENADES, SQUARES AND GARDENS. ....	20

## COMUNES, LA PALMA AND TENERIFE

C-1) ORNAMENTAL LIGHTING OF PUBLIC BUILDINGS, MONUMENTS, GARDENS AND UNDERWATER. ....	21
SPECIAL CASES: .....	23
C-2) WINDOW LIGHTING AND ILLUMINATED ADVERTISEMENTS .....	25
C-3) LIGHTING OF SPORTS AND RECREATIONAL FACILITIES .....	28
C-4) LIGHTING OF FESTIVE FACILITIES .....	29

## ANNEXES: .....

Annexo - This:	
"LIGHTING CRITERIA WITH SPECIAL-USE LUMINAIRES" .....	32
Annexo - B:	
MINIMUM DOCUMENTATION TO BE INCLUDED IN PROJECTS FOR OUTDOOR LIGHTING INSTALLATIONS IN PROTECTED AREAS FOR THEIR EVALUATION WITH RESPECT TO LIGHT POLLUTION .....	41
ANNEX - C:	
STANDARD SHEET FOR MOTORIZED AND PEDESTRIAN ROAD LIGHTING .....	43
Annexo - D:	
PRACTICAL GUIDE TO LIGHTING LEVELS ACCORDING TO EN-13201 AND RD 1890/08 .....	45
Annexo - A:	
DESCRIPTION OF VIOLATIONS OR DEFICIENCIES AND THEIR CLASSIFICATION .....	47

## OTHER PROCEDURES AND TECHNICAL INFORMATION OF THE IAC IN

[www.iac.es/otpc/documentos](http://www.iac.es/otpc/documentos):

- [List of luminaires and lamps certified by the IAC.](#)
- [Summary of recommendations for outdoor lighting.](#)
- [Procedures for the certification of luminaires and lamps.](#)

## GENERAL

### G-0) SCOPE OF APPLICATION:

The whole of the island of La Palma and, from April 22, 1992, in new facilities in the part of Tenerife with a direct view from La Palma (from the summit to the sea passing through the strip that joins the areas of Roques de Anaga, Punta del Hidalgo, Teno and Arona (to Las Galletas, Costa del Silencio). See zoning plan in lighting\_design\_aids [www.iac.es\otpc](http://www.iac.es\otpc)

The types of facilities affected (Articles 4 and 5 of the Regulation), merely enumerative, and not exclusive, are:

- Motorized and pedestrian street lighting.
- Pedestrian lighting in squares, gardens, promenades and paths.
- Parking lot lighting.
- Ornamental lighting: public buildings, monuments, gardens, fountains, swimming pools, lighting elements.
- Sports lighting.
- Recreational, party and spectacular lighting.
- Illuminated advertisements.
- Lighting of large areas, security and surveillance.
- Lighting of ports and airports.
- Lighting of shop windows, commercial areas and accesses to buildings or premises.
- Outdoor lighting of industries, service stations (including open indoor areas that can reflect their light to the sky, such as canopies with light floors).
- Outdoor lighting in workplaces.
- Exterior lighting of private homes.

Excluded are: light produced by combustion, navigational aid beacons and vehicle lights.

### G-1) BASIC CRITERIA:

- 1.- Avoid the emission of direct light into the sky.
- 2.- Avoid excesses in lighting levels (reflected light), before and after midnight.
- 3.- The use of light cannons or lasers is prohibited.
- 4.- Mercury vapor or white lamps are prohibited except for recreational, sports, ornamental, illuminated and pedestrian lighting. In pedestrian areas, discharge lamps with emission  $< 440 \text{ nm}$  ( $\sum R(\lambda < 440) < 15\%$  of the total) are prohibited, in LEDs see definitions of warm and super warm and their use. Other VSAP or VSBP or equivalent.
- 5.- In illuminated advertisements, high-pressure discharge lamps are prohibited.
- 6.- Design the installations with maximum utility (utilance) ( $U \geq 50\%$ ) (Special case in La Palma  $U \geq 75\%$ )
- 7.- Before midnight:
  - Switching off ornamental, recreational, sports lighting and illuminated advertisements.



- Use suitable lamps with low blue and no ultraviolet emissions.
- Reduce lighting to the minimum recommended levels by adapting to the temporary activity (See annex "D" Practical guide to levels according to EN13201 and RD 1890/2008).

### G-2) CERTIFIED LUMINAIRES AND LAMPS. General notes on its use.

The IAC will certify the lamps (light sources) and luminaires to be used in the protected areas for the purpose of obtaining photometric and spectral radiance data, verifying their adequacy to the Protection Regulations and subsequent evaluation of their impact in the technical reports, and obtaining the guarantee from the manufacturers to maintain these parameters when their products are demanded. The certification procedures are published on the IAC's website ([www.iac.es/otpc/documentos](http://www.iac.es/otpc/documentos)) and as well as the updated table with the list of lamps and luminaires. The luminaires and lamps will comply with the specifications of article 2 of Law 31/88 and articles 6 to 14 of the RD. 243/92 and RD. 580/2017 and the recommendations of the International Astronomical Union (Div. XII /Commission 50 WG Controlling Light Pollution TRIENNIAL REPORT 2009-2012).

This list of luminaires and lamps certified online is what determines which luminaires and lamps can be used in the protected area and which have a valid certificate. Exceptions are those lamps in uses in which the Regulations do not limit their spectral radiation. Asymmetrical front projectors do not need to be certified except to provide the verifiable photometric information (LDT) and to certify the lamp in case its radiance is limited by the regulations.

White light discharge lamps will be certified according to article 7 of the RD. 1890/2008 (all normally used sodium lamps comply) and LEDs according to the definitions described in section G-8 of this catalogue.

**Certified luminaires with discharge lamps: FHSint  $\leq 0.05\%$**  (generally 0%) (flat or transparent lenticular glass closures or closure within an opaque enclosure). Lenticular closures with a span of up to 1cm with FHSint  $\leq 0.05\%$ ,  $I < 4 \text{ cd/Klm}$  at  $\alpha=90^\circ$ ,  $I < 1 \text{ cd/Klm}$  at  $\alpha=95^\circ$  and  $I = 0$  to  $\alpha>95^\circ$  ( $\alpha = \text{gamma angle}$ ,  $\alpha=90^\circ$  is the horizon) are assimilated to "flat glass".

**Luminaires certified with LED: FHSint null** (class G6 type with respect to gamma  $\geq 90^\circ$ , according to annex A EN13201-2015). Any optic with a horizontal flat glass closure, or other closure, that does not protrude from the luminaire (recessed) shall be presumed to comply with this classification.

If the luminaire has a lower structure (lantern with open sides) it will be matte black. The luminaires will be installed **without inclination**, *with special care* with those with transparent lenticular closures. Plastic closures or diffusers (such as lantern panels, domed closures) or optical or refractors shall not be used if they are visible in or on the imaginary horizontal plane tangent to these elements in their lowest part.

### G-3) ABBREVIATIONS/Glossary:

FHSint = % Flux in the Upper Hemisphere of the total luminaire outgoing

ORM = Roque de Los Muchachos Observatory

IAC = Instituto de Astrofísica de Canarias

OTPC = Technical Office for the Protection of the Sky of the IACIa Calidad

VSBP = Low Pressure Sodium Vapor

VSAP = High Pressure Sodium Vapor

IAC AMBER LED: or with amber filter, does not emit below 550 nm ( $(\sum R(\lambda < 550)) < 7\%$  of the total),  $R(\text{blue})/R(\text{max.}) < 1/50$ , maximum  $595 \pm 10 \text{ nm} \approx \text{VSAP} (*)$

IAC PURE AMBER LED:  $595 \pm 10 \text{ nm}$  HMBW  $< 18 \text{ nm}$  monochrome amber light  $\approx \text{VSBP} (*)$

LED BLANCO CÁLIDO IAC: relación  $\sum R(\lambda < 500) / \sum [R(\lambda) \times V(\lambda)] \leq 0,25$  y  $R(\lambda_p < 500) / \sum [R(\lambda) \times V(\lambda)] \times 100 \leq 0,6$  (\*).

LED SÚPER CÁLIDO IAC: la relación  $\sum R(\lambda < 500) / \sum [R(\lambda) \times V(\lambda)] \leq 0,15$  y  $R(\lambda_p < 500) / \sum [R(\lambda) \times V(\lambda)] \times 100 \leq 0,4$  (\*).

R( $\lambda$ ): Function of the spectral radiance of a light source.

$\sum R(\lambda < 500)$  is the sum of the spectral radiances for all wavelengths below 500 nm.

V( $\lambda$ ): CIE function 1931.  $\sum [R(\lambda) \times V(\lambda)]$  is the integral of the product, in practice the sum of the matrix product, of these two functions for all wavelengths contained in a range (usually between 380-780nm).

VM = High pressure mercury vapor.

VMHM = Mercury Vapor with Metal Halides.

VP = Flat (or photometrically similar) glass closure.

ZAS = **high sensitivity area, La Palma (ZONE E0)**

U = utility (utilance) =  $f_u / \eta$ ;  $\eta$  = luminaire performance.

U = average level in lux ( $f_m=1$ ) x calculation surface in m<sup>2</sup> / installed lumens protruding from the luminaire, in the study section.

LED: light-emitting diode.

Minimum Distance Formula (meters) Special Use:  $\text{Outflow} \times 2/100$  (10 lux)

(\*) See definitions in section G8

#### G-4) HIGH SENSITIVITY ZONE:

In this document, a **high sensitivity area** (ZAS) is defined as one located less than 9 km from the ORM or with direct vision to the ORM in the territorial area of the island of La Palma.

#### G-5) SCREENED URBAN AREA:

In this document, a **screened urban area** (ZUA) is an urban area where the lighting installation is surrounded by buildings or by a nearby natural obstacle (less than 100m) in the direction of the observatory, and in such a way that the average height of the buildings (or the obstacle) is greater than the result of adding the height of the luminaire and the average distance from these to the buildings (or nearby obstacle). The reference of the height of the buildings will be with respect to the base of the lamp post of the highest or most unfavourable height.

#### G-6) PROHIBITIONS, SHUTDOWNS AND FLOW REDUCTIONS:

**Neither before nor after midnight may projectors or luminaires be used that do not prevent direct light emission on the horizon, light cannons or lasers** ( articles 2 of Law 31/88 and 6, 8, 12 and 14.2 of RD. 243/92).

**The switch-offs and flow reductions** required by law (articles 6, 11, 12, 13 and 14 of RD. 243/92) will be guaranteed by the use of time switches (programmed no later than 11:45 p.m. and until dawn) with a minimum autonomy of 100 hours and automatic summer/winter time change, or similar device (according to Art. 8 RD.1890/2008), and arranged in a place not accessible by unauthorized personnel. In installations of sporadic use (sports) where there is a manual switching on and off of the lighting system, the time switch will prevail over any manual control. In addition, it is advisable to install an indelible sign on the control panel warning of the obligation to turn off the installation no later than 12 noon, mentioning the corresponding legislation (Law 31/88 and RD 243/92).

In systems controlled by computer or remote management (for example in hotels) the program must warn the operator of the legally established shutdown time and the warning must be indicated in the user manuals of the lighting management system or program. The program will not allow you to program switch-ons or flow increases, prohibited after 12 p.m., without a prior password.

**Flow reductions must begin before 12 noon (11:45 p.m.) so that their reduction is effective at this time.** In centralised devices with voltage reduction, the nominal reduction voltage (VSAP reduce to 60% the flow corresponds to 175V-180V) will be indicated.

It is recommended that in voltage reduction systems or double-level ballast systems, accidental start-up of the installation at reduced voltage is prevented, allowing at least 5 minutes of delay to pass (micro-cuts, differential re-engagements).

The single-line electrical diagram shall show and identify these elements.

When autonomous programmable electronic equipment **is used**, it will be justified how the system complies with the reduction schedule (before 24h).

If your schedule is regulated by the duration between switching on and off the installation (see figure 1), the arithmetic midpoint (vertical dotted line in figure 1) corresponds to 01 am in official time in winter and 02 am in summer, so you must reduce (usually up to 50%) before 23 hours during winter time and before 24 hours in summer. plus 30 minutes of margin of error in the actual operating hours. For this reason, the reduction (50%) of the flow will be maintained no less than 6 hours after the arithmetic midpoint and **will begin 2.5 hours before this point** (according to Figure 1).

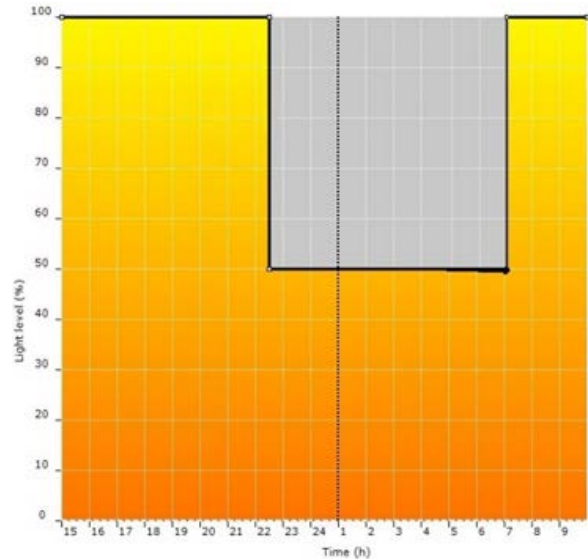

Figure 1. Autonomous regulation.

They will self-program with at least the data of the last 3 nights, they **will not affect their programming for ignitions of less than 4 hours or more than 22 hours, and micro cuts of less than 120ms will not affect their current operating status.** In these cases, switching on and off must be ensured by an astronomical time switch (or photocell).

Systems that use batteries (not recommended) should specify the expiration date of the system on which it will be replaced.

With LEDs, it should be noted that the mandatory reduction in flow is not linear with the reduction in power (mA). Normally, more power should be reduced for a smaller reduction in flow due to the increase in efficiency.

The results of levels and reductions should be measured and checked during commissioning (or on a sample) and the programming should be adjusted if necessary (the point illuminance under a luminaire can serve as a reference between calculations and measurements, assuming that the correct photometry has been used).

## G-7) LIGHTING LEVELS AND UTILITY (UTILANCE) CALCULATION:

Lighting levels before midnight should be adjusted as closely as possible to the minimum levels recommended for outdoor use (see annex "D" PRACTICAL GUIDE TO LIGHTING LEVELS ACCORDING TO EN-13201 AND RD 1890/08, o Summary of recommendations for the lighting of Outdoor Installations or Open Spaces on the IAC website [www.iac.es/otpc/documentos](http://www.iac.es/otpc/documentos)). **After 12 pm**, the levels **will fit** to the recommended minimums by adapting **change of use of the installation or to a lower class** because there are fewer users (generally, all installations end their use as security or lighting **lower class**) (Articles 6 and 11 of RD. 243/92). In accordance with Art. 11 of RD. 3243/92 must reduce the lighting levels from midnight to the minimum class specified according to RD.1890/2008 (or reduce to 1/3). The recommendations of the IAC in this regard may be followed, indicating the classification of the road and accompanying the corresponding lighting calculation. For example, residential and pedestrian roads are eligible for class P4 if no higher class is justified after this time (ver anexo "D").

*UTILANCE. For its **calculation, only the useful area to be illuminated (which will include the maximum illuminance point value) will be taken into account, and it will only be accepted to obtain average level values\_ from areas where the minimum point levels are greater than 1/10 of the maximum point ( $U_e > 10\%$ ). The maximum point value should never exceed twice the maximum average allowed ( $E_m + 20\% \times 2$ ). In scattered lighting ( $U_e < 10\%$ ), this maximum point value will determine the type of lighting and not the average.***

The "U" utility (utilance) must be equal to or greater than 50% to consider a value of medium or maximum point level illumination valid It will be calculated between two consecutive points of light in an area representative of each type of installation. If this is not possible, a useful area will be used between several points.

The calculation of the "U" utility (utilance) will be carried out on the **overall useful area** that the environment will contain. To define this surface where to calculate the **overall illuminance** without maintenance ( $f_m=1$ ), the following rules will be followed:

- On open roads or paths, an additional strip on each side of the road equal to half the width of the road up to a maximum of 5m will be considered (see EN13201-2015 for more cases). If there are walls in any of these strips, a maximum of 1m from the wall will be considered. (Shoulders and sidewalks are included in the environment). If there are signposted car parks, the width of the car parks will be included in the vicinity of the side of the road on which they are located (if both widths coincide or the width of the car park is greater, the latter will be used by adding 1 m more).
- In open pedestrian areas, for example with gardens on both sides, a strip on each side of 2m is considered. If there are walls in any of these strips, a maximum of 1m from the wall will be considered.

On roads with pedestrian paths (sidewalks), the widest calculation strip resulting from applying only the width of the road and its surroundings (sidewalk in the surroundings) or road plus open pedestrian area plus pedestrian environment will be considered.

- **Note:** The average overall illuminance maintained may not exceed the level of the assigned lighting class or exceed the maximum point value (if higher than the maintained illuminance of the usable area).

## **G-8) USE AND EQUIVALENCES OF LEDS (Not admissible emissions < 380nm or peaks <440nm):**

The objective of the regulations in this type of lamps is to reduce as much as possible their high blue component (low wavelength, less than 500nm) since the scattering of light in the atmosphere (luminous glare – sky glow) is inversely proportional to its wavelength at the fourth power and on the other hand when its light is dispersed it overlaps with valuable information from the light of the stars. Although the ideal is to use monochromatic LEDs with a very narrow amber spectrum, such as the one specified below as "PURE AMBER IAC LED", the reality is that in the market (2010-2017) these LEDs have a low efficiency (half that of the IAC Amber LED) and a great dependence on the flux emitted with temperature and do not make them very economically viable in large installations (although they can be used as they are exempt from complying with the the efficiency specified in RD 1890/2008 in this protected area).

The IAC PURE AMBER LED has no restrictions on use and can be used with the requirements of VSBP lamps.

IAC amber LEDs can be used with VSAP lamp requirements. Its use is limited on the island of La Palma and without restrictions on the island of Tenerife below 1000m in altitude.

The IAC SUPER WARM WHITE LED is generally intended for use in urban pedestrian areas, on a limited basis in La Palma and without restrictions in Tenerife.

The IAC WARM WHITE LED is intended for use in urban pedestrian areas in Tenerife below 1000m in height and in La Palma only before midnight.

### **LEDS EQUIVALENT TO THE VSAP: "IAC AMBER LED":**

IAC Amber LEDs must meet the following specifications: less than 0.60% of the sum of the spectral radiances for all wavelengths below 440nm, less than 1.5% of the sum of the spectral radiances for all wavelengths below 500nm and less than 7% (10% with filter if they have zero spectral radiance in the blue spectrum and less than 1% of the sum of the spectral radiances for all wavelengths less than 500nm) of the sum of the spectral radiances for all wavelengths below 550nm, with respect to the total radiance, measured in the range of 350-800nm (380-780nm if the radiance is zero outside this range), with maximum radiance value at  $595\pm 10\text{nm}$  and average bandwidth less than 90nm (110nm with filter); Nor shall there be a singular spectral radiance below 500nm that exceeds 1/50th of the maximum radiance of the LED (zero with filter), and at least the sum of the spectral radiance for all wavelengths between 550nm and 700nm shall be 90% (86% with filter) with respect to the total radiance.

### **LEDS EQUIVALENT TO VSBP: "IAC PURE AMBER LED":**

Pure Amber LEDs must meet the following specifications: 0% of the sum of the spectral radiances for all wavelengths below 500nm and less than 0.5% above 700nm, less than 0.5% of the sum of the spectral radiances for all wavelengths in the 500-550nm range and less than 0.5% in the 650-700nm range, measured against total radiance in the range of 500-700nm; There will not be a single emission in these ranges that exceeds 1/100 of the maximum emission of the LED; maximum value at  $595\pm 10\text{nm}$  and average bandwidth equal to or less than 18nm.

### **WARM WHITE LEDS: "IAC WARM WHITE LED":**

*IAC warm white LEDs* must meet the following specifications: the sum of the spectral radiances for all wavelengths below **500nm**,  $\sum R(\lambda < 500)$ , per unit lumen,  $\sum [R(\lambda) \times V(\lambda)]$ , must not exceed **0.25** measured in the range of 350-800nm (380-780nm if the radiance is zero outside this range) and any singular emission below 500nm (blue) shall not exceed the value of

**0.6** obtained by dividing the maximum singular radiance by lumens and multiplied by 100 ( $R(\lambda_{p<500}) / \sum[R(\lambda) \times V(\lambda)] \times 100 \leq 0.6$ ); Maximum radiance value at  $595 \pm 10 \text{nm}$ . Current warm white LEDs with a temperature below **2,700°K** and reduced blue emission, **<0.36** the ratio between maximum blue/amber radiances, could meet this criterion. (\*)

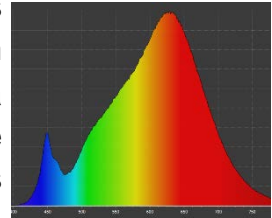

**SUPER WARM WHITE LEDS: "IAC SUPER WARM WHITE LED":**

For *IAC super warm white LEDs* (restricted use on La Palma), the specification is established as follows: the sum of the spectral radiances for all wavelengths below **500nm**,  $\sum R(\lambda < 500)$ , per unit lumen,  $\sum [R(\lambda) \times V(\lambda)]$ , shall not exceed **0.15** measured in the range of 350-800nm (380-780nm if the radiance is zero outside this range) and any singular emission below 500nm (blue) shall not exceed the value of **0.4** obtained with the radiance division

Maximum singular between lumens and multiplied by 100 ( $R(\lambda_{p<500}) / \sum [R(\lambda) \times V(\lambda)] \times 100 \leq 0.4$ ); maximum radiance value at  $595 \pm 10 \text{nm}$ . Current warm white LEDs with a temperature below **2,200°K** and reduced blue emission, **<0.23** the ratio between maximum blue/amber radiances, could meet this criterion. (\*)

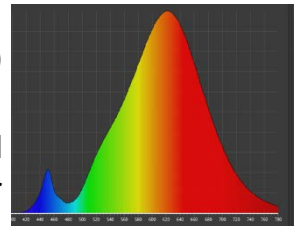

(\*) It is noted that the color temperature is not a valid criterion but an approximate one for the definition of this type of lamp.

**SPECIAL CASE OF USING IAC AMBER LEDS ALL NIGHT IN LA PALMA:**

Instead of VSBP or Pure Amber LEDs, IAC Amber LEDs may be used all night in La Palma (street/pedestrian/square/large area lighting) with the following specifications: this type of lighting must be required to have a utility (utilance) factor ("U") that is not less than 75% (65% in roundabouts or irregular areas) and that it has an automatic flow reduction control system by presence detection, or similar, that maintains the flow at no more than 20% of the initial flow when it does not detect people or vehicles (for example, no detection for a period of more than 5 minutes). The levels with detection after 24h will be half of the initial or the type of lighting that corresponds to that time.

If detection is not feasible, maximum levels of the following may be chosen, from 12 p.m., onwards: a) project situations **D, B2** and **lighting in general**, class P5 in the case of roads with parked vehicles and P6 on roads without parked vehicles and safety; b) situation **E** (Pedestrian), P4 in pedestrian or main square of the urban center and P5 rest; c) situations **A1, A3** and **B1**, class M6/P4 (or 1/3 of the corresponding class before midnight). In practice, the level is usually 1/3 of the corresponding lighting class before midnight. The minimum uniformity of the corresponding class must be maintained.

***In the event that these technical specifications cannot be implemented, the IAC Pure Amber LED must be used.***

**SPECIAL CASE OF USING SUPER WARM WHITE LEDS ALL NIGHT IN LA PALMA:**

In an exceptional, discreet, screened and exclusively pedestrian way, within the main urban core of the municipality, where an exceptional area of pedestrian confluence of citizens after midnight can be considered, with commercial and leisure activities, the use of the IAC SUPER WARM WHITE LEDs defined in the previous section could be studied with the same technical specifications as the use of the IAC Amber LED. The use of this

option should be restricted and subject to very particular areas of the urban center and not extensively, following a technical report from the IAC.

#### **SPECIAL CASE OF USE OF IAC WARM LEDS IN TENERIFE IN A PREDOMINANTLY PEDESTRIAN ENVIRONMENT OF COMMERCIAL/TOURIST AREAS CROSSED BY A ROAD:**

In the commercial and tourist areas of Tenerife, with a large influx of night-time visitors, which are predominantly pedestrian and are crossed by a motorised road with a width of less than 1/3 of the total (pedestrian + road) and signposted as preferably pedestrian traffic and limited speed ( $\leq 20$  km/h), without parking (only public service stops), they may be considered globally as pedestrian lighting.

#### **G-9) IAC TECHNICAL REPORTS:**

The IAC's technical reports are prior, mandatory and decisive for the authorisation and licence of the installations and in any case issued before the commissioning and execution of the same. The deadline for issuing the report is 30 days. Article 5 of Law 31/88 and 27 and 28 of RD. 243/92.

The period of suspension of the administrative file of license and authorization pending the response to the request for this prior and mandatory report may not exceed 3 months.

#### **PROCEDURE RELATING TO OBTAINING THE PRIOR AND MANDATORY TECHNICAL REPORT FROM THE IAC:**

The OTPC portal [www.iac.es/otpc/documentos](http://www.iac.es/otpc/documentos) indicates the procedures related to the request for technical reports, which is reproduced below:

- Issuance of technical lighting reports: Projects with a quality visa and/or validable electronic signature must be sent through the [IAC Electronic Office](#). They can also be submitted in paper or digital format at the IAC registry or by ordinary mail at C/ Vía Láctea s/n, 38200 San Cristóbal de La Laguna, for the attention of the OTPC accompanied by the corresponding [official letter](#).
- Inquiries can be sent to the OTPC ([otpc@iac.es](mailto:otpc@iac.es))
- [Official letter requesting technical reports](#), electronically signed by the applicant with validable signature (March 2015) (pdf, 54Kb)

You can also make use of other administrative records regulated by Law 39/2015, of 1 October, on the Common Administrative Procedure of Public Administrations. In this case, you can access the electronic offices of the ministerial departments and other public administrations integrated in the Registry Interconnection System.

In the event of sending very large files, not supported by the electronic offices, the electronic means considered most appropriate for sending them as an annex to the application letter sent by the administrative registry must be agreed.

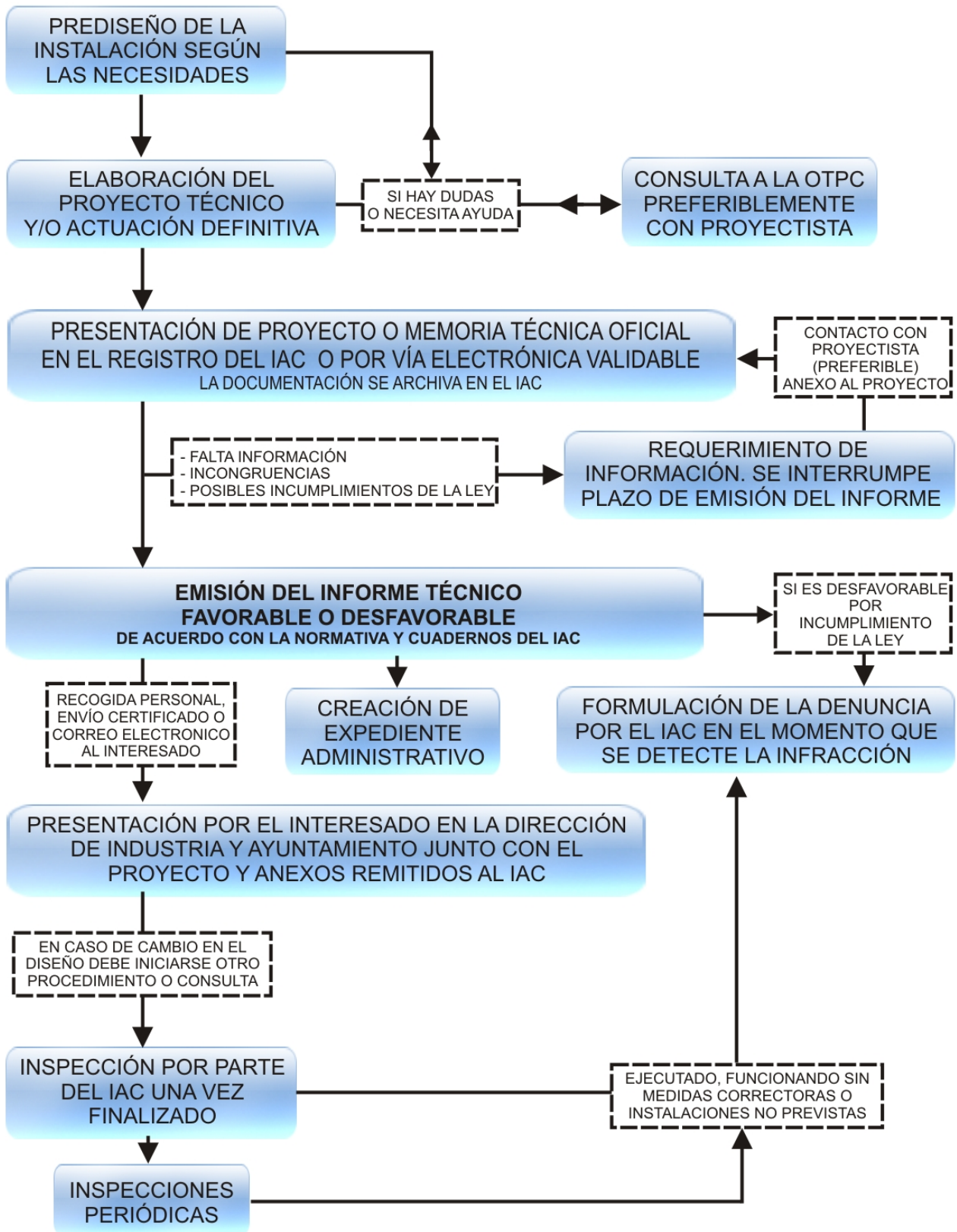

## ISLAND OF TENERIFE

### T-1) STREET LIGHTING, CAR PARKS, LARGE AREAS AND SECURITY:

#### Lamps: in general VSAP – VSBP LEDs AMBER IAC – PURE AMBER IAC:

In areas above 1,000m above sea level, the technical specifications of the island of La Palma will be used.

#### Luminares: Luminares certified according to section G-2.

In areas above 1000m and in open spaces (rural) only type **FHSint null** Installed No tilt.

#### **Roads, motorways and carriageways:**

On roads and motorways (situation A) in open countryside and outside urban center, luminares with **FHSint null type closures** without inclination (**max.  $\pm 5^\circ$**  if it admits it).

The choice of lighting classes higher than the minimum recommended (M4 on roads and P4 on residential roads) will be justified with official data and the illuminance criterion (C4) will be used if the type of asphalt is not reliably known, recommending R3 ( $q_0=0.07$ ) for the purposes of calculating quality parameters.

#### **Use of luminares in urban areas:**

In urban areas, luminares with discharge lamps with FHSint  $\leq 0.05\%$  (lenticular closure) **may be used.**

#### **Projector Usage:**

The projectors will be installed without tilting (horizontal flat glass closure). Its photometry will be in accordance with the area to be illuminated, using, in general, projectors that are asymmetrical from the front (angle of asymmetry) so that the tangent of the angle of asymmetry times the height of installation gives us the length of the area necessary to illuminate in front of the projector (angle of throw = angle of arctangent asymmetry  $\approx$  (length to be illuminated in front of the projector / Installation height))

**The front reach angle ( $I_{\text{máx.}}$ ) will never be higher than  $70^\circ$  and the intensity above  $85^\circ$  will be less than 50cd/KLM.**

If more than two projectors are used on the same column, excessive point illumination (at the foot of the column) must be avoided by using projectors with a ratio between maximum intensity ( $I_{\text{máx.}}$  at the angle of asymmetry) and that directed towards the base of the column ( $I_{\alpha=0^\circ}$ ,  $\gamma 0^\circ-10^\circ$ ) greater than 3.

The projects must have detailed information on the location, pointing and inclination of the projectors with their corresponding lighting calculation. Projectors with grilles or visors will not be accepted without a prior technical certification of compliance with flat glass or **FHSint null luminaire**.

Care must be taken to ensure that the utilisation (U) on the illuminated road or area is greater than **50%**, avoiding placing the projectors away from the area to be illuminated or, where appropriate, minimizing the light projected in the area that is not useful. For example, in the case of roundabout lighting with installation in a central column, the radius of the landscaped roundabout must be less than the height of the tower or avoid illuminating the garden area after midnight in accordance with the Law (garden lighting) except for that corresponding to the vicinity of the road.

#### **Lighting levels:**

RD.1890/2008 will be followed, which considers minimum levels as maximum levels up to 20% of them (see annex "D" PRACTICAL GUIDE TO LIGHTING LEVELS ACCORDING TO EN-13201 AND RD 1890/08, o Summary of recommendations for the lighting of Outdoor Installations or Open Spaces on the IAC website [www.iac.es/otpc/documentos](http://www.iac.es/otpc/documentos)). From

midnight (11:45 p.m.) the levels will be reduced to 50% (or at least a lower class) and/or adjusted to the change of use or to the new parameters of lower level. These reductions must not reduce uniformity or be less than those recommended for the new and inferior lighting class.

**Before and after midnight , the corresponding level shall not exceed 20%.**

The project will indicate and describe the type of road or enclosure to be illuminated, design values and their justification (if they are not the recommended minimums) and lighting calculations indicating the distribution, height and inclination of the luminaires, setbacks and width of the tracks (or dimensions of the enclosure).

The design will be such that a **≥50% U is obtained.**

**Annexes "B" and "C" contain the** minimum information required for IAC technical reports and a help sheet for providing data.

#### **Exceptional use of low light pack lamps:**

In isolated cases in which, due to the requirement of a small width or small size of the area to be illuminated, low powers ( $\leq 450\text{lm}$  projecting) are used at low heights ( $\leq 3\text{m}$ ), the criterion of Special Use type A with Amber IAC LEDs may be used according to annex "A".

#### **Security lighting with motion detectors:**

In the case of specific lighting where an installation is normally switched off and with temporary instantaneous deterrent ignition, lamps with instantaneous ignition may be used, complying with the criterion of Special Use type A (see annex "A"). The luminaires shall prevent the flow of light over the horizon and shall be designed in such a way that the pointing angle does not exceed 70° ( $1.5 > \text{height/distance to be illuminated} > 1/3$ ).

In these small and powerful projectors, the lamp (or LED) will be installed horizontally, without protruding from the projector, and their optics will have an adequate asymmetry and/or will have visors suitable for the inclination of the same so that the lamp is always above the furthest end of the visor, without emitting light on the horizon.

The power of the lamps will be chosen according to the minimum recommended lighting levels (normally for safety: 5 lux) without exceeding 450 lm output.

## **ISLAND OF TENERIFE**

### **T-2) PEDESTRIAN STREET LIGHTING IN PROMENADES, SQUARES AND GARDENS.**

**Lamps:** in general VSAP – VSBP or LEDs AMBER IAC - PURE AMBER IAC:

In areas above the 1,000m above sea level the technical specifications of the island of La Palma will be used.

**In exclusively pedestrian lighting and gardens in urban areas** , lamps may be used, before and after midnight, that comply with the specifications of article 7 of RD 243/92 for discharge lamps and in LEDs what is specified in this catalogue of specifications, such as Warm White Led IAC and Super Warm White Led IAC (See list of lamps and luminaires certified by the IAC). with a light package suitable for the installation height and corresponding lighting class.

**Luminaires:** Luminaires certified according to section G-2.

In urban areas above 1,000m as well as in open areas, FHSint null luminaires will be used exclusively .

## Projector Usage:

The projectors will be installed without tilting (horizontal flat glass closure). Its photometry will be in accordance with the area to be illuminated, using, in general, projectors that are asymmetrical from the front (angle of asymmetry) so that the tangent of the angle of asymmetry times the height of installation gives us the length of the area necessary to illuminate in front of the projector (angle of throw = angle of asymmetry  $\approx$  arctangent (length to be illuminated in front of the projector / Installation height))

**The front reach angle ( $I_{max.}$ ) will never be higher than 70° and the intensity above 85° will be less than 50cd/KLM.**

In the case of using more than two projectors on the same column, excessive point illumination (at the foot of the column) should be avoided by using projectors with a ratio between maximum intensity ( $I_{max.}$  at the angle of asymmetry) and that directed towards the base of the column ( $I_{\alpha-0^{\circ}}$ , gamma  $0^{\circ}$ - $10^{\circ}$ ) greater than 3 (See list with examples of projectors published on the IAC website,  $I_{max.}/I_{\alpha-0^{\circ}}$ ).

The projects must have detailed information on the location, pointing and inclination of the projectors with their corresponding lighting calculation. Projectors with grilles or visors will not be accepted without a prior technical certification of compliance with flat glass or **FHSint null luminaire**.

Care must be taken to ensure that the utility (utilance) (U) in the area to be illuminated is greater than **50%**, avoiding placing the projectors away from it or, where appropriate, minimizing the light projected in the non-useful area. In this regard, it is recommended that the start of the useful area to be illuminated should be at a distance from the base of the column of the projectors not exceeding the value of the height of the column.

## Lighting levels:

RD.1890/2008 will be followed, which considers minimum levels as maximum levels up to 20% of them (see annex "D" PRACTICAL GUIDE TO LIGHTING LEVELS ACCORDING TO EN-13201 AND RD 1890/08, o Summary of recommendations for the lighting of Outdoor Installations or Open Spaces on the IAC website [www.iac.es/otpc/documentos](http://www.iac.es/otpc/documentos)). From midnight (11:45 p.m.) the levels will be reduced to 50% (or at least a lower class) and/or adjusted to the change of use or to the new parameters of lower level. These reductions must not reduce uniformity or be less than those recommended for the new class of lower lighting.

**Before and after midnight , the corresponding level shall not exceed more than 20%.**

The project will indicate and describe the type of road or enclosure to be illuminated, design values and their justification (if they are not the minimums recommended) and lighting calculations indicating the distribution, height and inclination of the luminaires, setbacks and width of the tracks (or dimensions of the enclosure).

**Annexes "B" and "C" contain the** minimum information required for IAC technical reports and a help sheet for providing data.

## Use of low luminous package lamps:

In this type of lighting, low-light lamps may be used in accordance with the **Special Use criteria** (see annex "A").

## ISLAND OF LA PALMA

### P-1) STREET LIGHTING, CAR PARKS, LARGE AREAS AND SECURITY:

**Lamps:** in general VSBP or IAC PURE AMBER LEDS (IAC AMBER with special specifications, see section G-8):

In urban areas, VSAP or AMBER IAC LEDS may be used, until midnight (11:45 p.m.) (AMBER IAC all night with special specifications, see section G-8).

**Luminaires:** FHSint null luminaires, without tilt (max.  $\pm 5^\circ$  if it admits it).

#### **Roads, motorways and carriageways:**

The choice of lighting classes higher than the recommended minimum (M4 on roads and P4 on residential roads) will be justified with official data and the illuminance criterion (C4) will be used if the type of asphalt is not reliably known, recommending R3 ( $q_0=0.07$ ) for the purposes of calculating quality parameters.

#### **Projector Usage:**

The projectors will be installed without tilting (horizontal flat glass closure). Its photometry will be in accordance with the area to be illuminated, using, in general, projectors that are asymmetrical from the front (angle of asymmetry) so that the tangent of the angle of asymmetry times the height of installation gives us the length of the area necessary to illuminate in front of the projector (angle of throw = angle of asymmetry  $\approx$  arctangent (length to be illuminated in front of the projector / Installation height))

**The front reach angle ( $I_{max.}$ ) will never be higher than  $70^\circ$  and the intensity above  $85^\circ$  will be less than 50cd/KLM.**

In the case of using more than two projectors on the same column, excessive point illumination (at the foot of the column) should be avoided by using projectors with a ratio between maximum intensity ( $I_{max.}$ , at the angle of asymmetry) and that directed towards the base of the column ( $I_{\alpha-0^\circ}$ ,  $\gamma 0^\circ-10^\circ$ ) greater than 3 (See list with example of projectors published on the IAC website, value of  $I_{max.}/I_{\alpha-0^\circ}$ ).

The projects must have detailed information on the location, pointing and inclination of the projectors with their corresponding lighting calculation. Projectors with grilles or visors will not be accepted without a prior technical certification of compliance with flat glass or **FHSint null luminaire**.

Care must be taken to ensure that the utilisation (U) in the area to be illuminated is greater than **50%** (or greater depending on the type of light source, 75%), avoiding placing the projectors far from the area to be illuminated or, where appropriate, minimising the light projected in the area that is not useful. For example, in the case of roundabout lighting installed in a central column, the radius of the landscaped roundabout must be less than the height of the tower or avoid illuminating the garden area after midnight in accordance with the Law (garden lighting) except for the corresponding road environment.

In **exclusively urban** and low-sensitivity areas (non-ZAS) with high-rise column installations (greater than 11m), the most appropriate technical and economic solution will be studied between using VSBP or mixed VSBP+VSAP lighting for the time required, according to justified needs. In the case of using LED technology, this exception is not necessary and it will be resolved with the same technical specifications indicated in the previous paragraphs (with the specifications of section G-8 according to the type of LED used).

#### **Lighting levels:**

RD.1890/2008 will be followed, which considers minimum levels as maximum levels up to 20% of them (see annex "D" PRACTICAL GUIDE TO LIGHTING LEVELS ACCORDING TO EN-13201 AND RD 1890/08, o Summary of recommendations for the lighting of Outdoor Installations or Open Spaces on the IAC website [www.iac.es/otpc/documentos](http://www.iac.es/otpc/documentos)). From midnight (11:45 p.m.) the levels will be reduced to 50% (or at least a lower class) and/or adjusted to the change of use or to the new parameters of lower level. These reductions must not reduce uniformity or be less than those recommended for the new type of lighting. In the case of using light with Amber IAC LEDs, it will be adjusted to the minimum class that corresponds to it and with  $U \geq 75\%$ , according to section G-8.

**Before and after midnight , the corresponding level shall not exceed more than 20%.**

The project will indicate and describe the type of road or enclosure to be illuminated, design values and their justification (if they are not the recommended minimums) and lighting calculations indicating the distribution, height and inclination of the luminaires, setbacks and width of the tracks (or dimensions of the enclosure).

The design will be such that  $U \geq 50\%$  **is obtained** (except IAC Amber,  $\geq 75\%$ ).

**Annexes "B" and "C" contain the** minimum information required for IAC technical reports and a help sheet for providing data.

**Exceptional use of low light pack lamps:**

In isolated cases in which, due to the requirement of the narrowness or small size of the area to be illuminated, low powers ( $\leq 450\text{lm}$  projecting) are used at low heights ( $\leq 3\text{m}$ ), the criterion of Special Use type A may be used with Amber IAC or Pure Amber IAC LEDs (see annex "A").

**Security lighting with motion detectors:**

Not applicable in ZAS areas within 9 km of the observatory, unless VSBP or IAC Pure Amber lamps are used.

In the case of specific lighting where an installation is normally switched off and with temporary instantaneous deterrent ignition, lamps with instantaneous ignition may be used, complying with the criterion of Special Use type A. The luminaires shall prevent the flow of light over the horizon and shall be designed in such a way that the pointing angle does not exceed  $70^\circ$  ( $1.5 > \text{height/distance to be illuminated} > 1/3$ ).

In these small and powerful projectors, the lamp (or LED) will be installed horizontally, without protruding from the luminaire, and their optics will have an adequate asymmetry and/or will have visors suitable for the inclination of the same so that the lamp is always above the furthest end of the visor, without emitting light on the horizon.

The power of the lamps will be chosen according to the minimum recommended lighting levels (normally for safety: 5 lux) without exceeding 450 lm output.

## ISLAND OF LA PALMA

### P-2) PEDESTRIAN STREET LIGHTING IN PROMENADES, SQUARES AND GARDENS.

Lamps: in general VSBP or PURE AMBER IAC LEDs (or IAC AMBER with special specifications, see section G-8):

**In exclusively pedestrian lighting and gardens in urban areas**, any warm light lamp certified by the IAC may be used with a luminous package appropriate to the type of lighting that corresponds to it and until 12 noon at night (guaranteeing its **switching off at 11:45 p.m.**), and must comply with the specifications of article 7 of RD 243/92 in discharge lamps and in the case of LEDs the specifications for Warm White LEDs IAC or Super Warm IAC (See list of lamps certified by the IAC in [www.iac.es/otpc/documentos](http://www.iac.es/otpc/documentos)). The use of warm white light after midnight is limited to the use of the Special Use criterion type A (see annex "A") with levels equal to or less than P4 (as the case may be) and to the exceptional case indicated in section G-8 with IAC Super Warm White LEDs.

Luminaires: FHSint null (flat glass type), no tilt.

#### **Projector Usage:**

The projectors will be installed without tilting (horizontal flat glass closure). Their photometry will be according to the area to be illuminated, using, in general, projectors with frontal asymmetry (angle of asymmetry) so that the tangent of the angle of asymmetry times the installation height gives us the length of the area necessary to illuminate in front of the projector (angle of throw = angle of asymmetry  $\approx$  arctangent (length to be illuminated in front of the projector / Installation height))

**The front reach angle ( $I_{max.}$ ) will never be higher than 70° and the intensity above 85° will be less than 50cd/KLM.**

In the case of using more than two projectors on the same column, excessive point illumination (at the foot of the column) should be avoided by using projectors with a ratio between maximum intensity ( $I_{max.}$ , at the angle of asymmetry) and that directed towards the base of the column ( $I_{\alpha-0^\circ}$ ,  $\gamma$  0°-10°) greater than 3 (See list of examples of projectors published on the IAC website,  $I_{max.}/I_{\alpha-0^\circ}$ ).

The projects must have detailed information on the location, pointing and inclination of the projectors with their corresponding lighting calculation. Projectors with grilles or visors will not be accepted without a prior technical certification of compliance with flat glass or **FHSint null luminaire**.

Care must be taken to ensure that the utilance in the area to be illuminated is greater than **50%** (75% Amber IAC or Super Warm IAC type), avoiding placing the projectors far from the area to be illuminated or, where appropriate, minimizing the light projected in the area that is not useful. The start of the useful area to be illuminated must be at a distance from the base of the column of the projectors not exceeding the value of the height of the column.

In **exclusively urban** and low-sensitivity areas (non-ZAS) with high-rise column installations (greater than 11m), the most appropriate technical and economic solution will be studied between using VSBP or mixed VSBP+VSAP lighting for the time required, according to justified needs. In the case of using LED technology, this exception does not apply and will be resolved with the same technical specifications indicated in the

previous paragraphs (with the specifications of section G-8 depending on the type of LED used).

**Lighting levels:**

RD.1890/2008 will be followed, which considers minimum levels as maximum levels up to 20% of them (see annex "D" PRACTICAL GUIDE TO LIGHTING LEVELS ACCORDING TO EN-13201 AND RD 1890/08, o Summary of recommendations for the lighting of Outdoor Installations or Open Spaces on the IAC website [www.iac.es/otpc/documentos](http://www.iac.es/otpc/documentos)). From midnight (11:45 p.m.) the levels will be reduced to 50% (or at least a lower class) and/or adjusted to the change of use or to the new parameters of lower level. These reductions must not reduce uniformity or be less than those recommended for the new type of lighting. In case of using light with IAC Amber or IAC Super Warm LEDs, it will be adjusted to the minimum class that corresponds to it and with  $U \geq 75\%$ , see section G-8.

**Before and after midnight , the corresponding level shall not exceed 20%.**

The project will indicate and describe the type of road or enclosure to be illuminated, design values and their justification (if they are not the minimums recommended) and lighting calculations indicating the distribution, height and inclination of the luminaires, setbacks and width of the tracks (or dimensions of the enclosure).

The design will be such that  **$U \geq 50\%$  is obtained (or 75% with IAC Amber or IAC Super Warm LEDs).**

**Annexes "B" and "C" contain the** minimum information required for IAC technical reports and a help sheet for providing data.

**Use of low luminous package lamps:**

In this type of lighting, low luminous package lamps may be used following the **criteria of Special Use** type A (see annex "A" of criteria with Special Use luminaires) for actions in small unique urban areas.

## **LA PALMA AND TENERIFE**

### **C-1) ORNAMENTAL LIGHTING OF PUBLIC BUILDINGS, MONUMENTS, GARDENS AND UNDERWATER.**

**Lamps: any:**

**It must be switched off before or no later than 12 noon at night (see section G-6).**

**Luminaires: that prevent the emission of light outside the area of action, and especially in the open air and in directions close to the horizon:**

These installations include lighting: ornamental lighting of **public** buildings, monuments and gardens. There is a wide range of devices to use depending on the location and size of the object to be illuminated, but all should avoid sending light out of the area to be illuminated. **Not applicable for private facades, or public facades with advertising, except declared BIC.**

**Projector Usage:**

The projectors will preferably be installed from the top down. Its optics must be adapted to the size of the object to be illuminated and its position with respect to the object. If necessary, visors, paralumens, baffles or external fins will be installed to guarantee light control outside the area of action.

For study or evaluation, floor plans, elevation and section of the object and location of the projectors, with their orientation, will be presented, together with the photometric data of the projector (vertical and horizontal beam, LDT) with the sketches, where appropriate, of the accessories, which allow it to be clearly determined that the emission of light outside

the area to be illuminated is avoided (intersection with the object of the main beams of light and those corresponding to 50cd/ Klum).

In any case, the main beam ( $1/2 I_{max}$ ) and the 50cd/klm beam must be intercepted by the object to be illuminated (to be justified) and the design will be such that a  $U \geq 50\%$  is obtained.

**BEAM CONCEPT (MAIN and 50cd/klm) AND INTERCEPTION WITH THE OBJECT TO BE ILLUMINATED.**

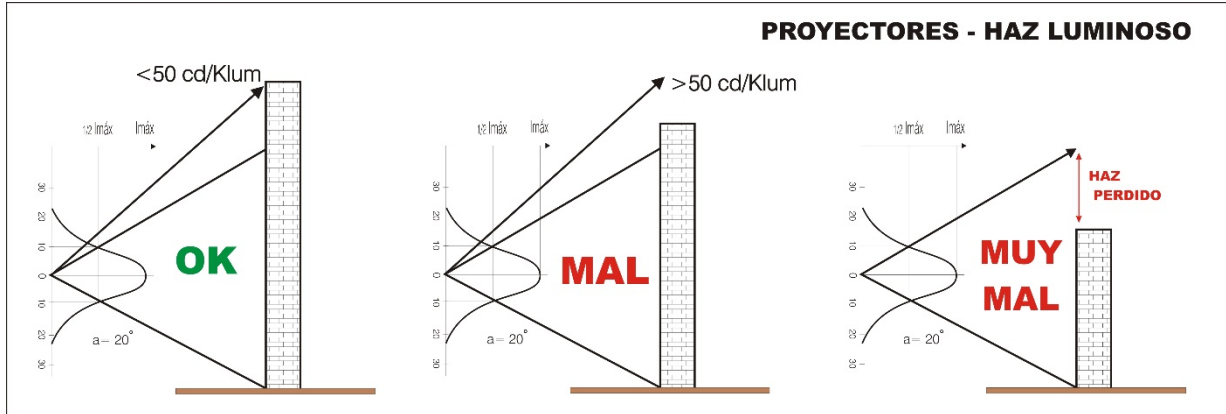

The provisions of RD.1890/2008 ITC-EA-04 3.1 will be strictly followed, among others:

- a) Horizontal surfaces: maximum pointing  $70^\circ$  and for angles greater than  $85^\circ$  intensity  $I \leq 50\text{cd/Klm}$ .
- b) Vertical surfaces: from top to bottom and if it is impossible the maximum pointing will be  $90^\circ+30^\circ$  (recessed in the ground is not allowed unless it has this pointing) and outside the object  $I \leq 50\text{cd/Klm}$  (the latter is mandatory on or over the open horizon for astronomical quality).
- c) Horizontal surfaces seen from below: This is the only situation with lighting from the ground (e.g. tree illuminated from the trunk), in this case, in addition to fitting the main beam with the object, outside object  $I \leq 50\text{cd/Klm}$  (in these cases the criterion "garden skewer" of Special Use is recommended).

**CONCEPT OF INTERCEPTION WITH THE OBJECT TO BE ILLUMINATED (From the ground).**

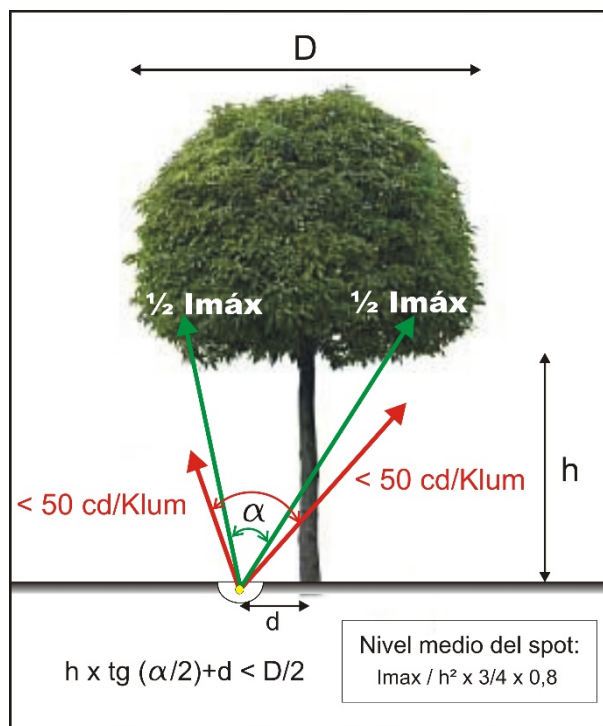

### **Use of low light package luminaires:**

For walks and paths through gardens, the Special Use criterion is recommended (see annex "A"). They do not require justification for the interception of the light beam greater than 50cd/klm if the "garden spike" criterion is used to illuminate any object or wall.

### **Lighting levels:**

RD.1890/2008 will be followed, which establishes a maximum brightness on facades of 5cd/m<sup>2</sup> for zones E1 and E2 (all areas protected by Law 31/88). Thus, dark/medium/light colors will have maximum average levels of 160/60/30 lux, respectively (point maximums not exceeding double). These levels can be exceeded up to a maximum of 20% ( $f_m \geq 0.8$ ). (See Summary of Recommendations for Outdoor Lighting on the IAC website [www.iac.es/otpc/documentos](http://www.iac.es/otpc/documentos)). Small details on the façade (coats of arms) can be highlighted with double the level if their surroundings are illuminated.

**From midnight (11:45 p.m.) all ornamental lighting will remain off every day of the year.** Its switching off must be independent of any other type of lighting that could temporarily be authorised to be switched off later (recreational or sporting).

The project will indicate and describe the type of object to be illuminated and justification of the design values.

### **SPECIAL CASES:**

- For **garden skewers** (simplified solution) with warm LEDs ( $\leq 3000^\circ\text{K}$ ) (450 lumens), their interdistance will be limited to a minimum in meters according to Special Use criteria (see annex "A") with the outflow formula for 40 lux. Only the interception of the main beam with the object to be illuminated will have to be demonstrated. For example, in palm trees it is used with a beam aperture between  $8^\circ$  and  $25^\circ$  depending on height and span (see previous figure  $h \times \text{tg}(\alpha/2) + d < D/2$ ).

- In **underwater lighting (swimming pools)**, suitable lamps with a maximum density of 30 lumens per square meter of water film (30lm/m<sup>2</sup>) evenly distributed will be used. Their interdistance will be limited to a minimum in meters according to Special Use criteria (Annex "A") with the output flux formula for 20 lux and the maximum power per point of light must not exceed 1000 lumens. The beam of light will be parallel to the sheet of water or downwards.

- **Illuminated floors:** if they are small in size ( $\approx 1\%$  of the surface,  $< 5\text{cm}$  wide) their initial brightness must not exceed 50cd/m<sup>2</sup> (assimilated to illuminated advertising), with a maintenance factor of 100%. If they are large surfaces, it will be assimilated to the lighting of facades (surfaces) with a level of 5cd/m<sup>2</sup>.

- **Safety signage:** For signage ( $\approx 50\text{mm}$ ), if they do not meet the Special Use criterion (annex "A"), colors between red and yellow must be used, between 575-625nm (not green, blue or white) with less than 10 lumens ( $\approx 0.1\text{w}$  in LED) or less than 50cd/m<sup>2</sup>. On stairs it can be used recessed in the riser with an opal diffuser or with optics with visors that direct the light to the ground. Maximum 10 lumens/meter of step or interdistance.

- Small **backlit objects:** they will be considered as light boxes (advertisement or illuminated sign). The brightness will depend on the island and location.

- Spot lighting (circular optics projectors) such as circles of light on the ground or on trees, the average illumination (lux) (unoverlapping beams of light) shall be calculated by dividing the maximum intensity (cd/klm x klm) by the distance (to the object) squared and multiplying by  $3/4 \times 0.8$  (average level corresponding to the spot light of the main beam of diameter =  $2 \times d \times \text{tg}(\alpha/2)$ , where "d" is the distance and "α" is the main opening angle). The maximum average illumination level will be determined by the color of the

illuminated surface. The maximum inclination is determined: less than 10cd/Klm in 90° gamma, less than 50cd/klm in 85° gamma and outside the illuminated object (complying with RD.1890/2008 ITC-EA-04 3.1).

- **Light sources** (spotlights illuminating jets or waterfalls from inside the water): currently, with the experience acquired, it is limited to the minimum interdistance between spotlights and flux per spotlight, following the formula of the Special Use criterion with outgoing flux for 60 lux and so that the main beam intercepts the illuminated object (in jets, beam < 10°). The minimum interdistance (meters) between spotlights for a maximum simultaneous outgoing flux "F" would be:  $F_{\text{saliente}} \times 2 / 100 \times 1/6$ . Each case will be the object of study but in general the maximum simultaneous power per bulb should not exceed 2000 lumens output.

- **Light hoses** or linear light. Special Use criteria (annex "A") are used for 10 lux, i.e. 156 lm/m installed as a maximum in general, in the case of direct emission LEDs 104 lm/m (lm installed) and using the value of the total output flux would be 50 lm/m output as a maximum.

## LA PALMA AND TENERIFE

### C-2) WINDOW LIGHTING AND ILLUMINATED ADVERTISEMENTS

**Lamps:** all except those with high pressure discharge:

**Switched off before or no later than 12 noon (see section G-6).**

**Luminaires:** that prevent the emission of light outside the area of action, especially in the open sky and in directions close to the horizon:

The use of light cannons, luminaires projecting light on the horizon or lasers for advertising, recreational or cultural purposes is prohibited.

#### **Windows:**

In shop windows or exhibitions in open spaces (with ceilings), any type of lamp may be used, avoiding direct light from the horizon.

At entrances to shops and outdoor exhibitions (without roofs), the same technical specifications of street lighting or large areas will be used, being able to use discharge lamps that comply with Art.7 of RD 243/92 and warm LEDs according to section G-8. Specific lighting levels greater than 50 lux (30 lux being considered normal) will be justified (generally discharge lamps of 2600 lumens or 1800 lm in warm light LEDs at a height of 4-5m and spaced 5-6m from each other).

#### **Illuminated signs or advertisements:**

These installations must avoid the emission of direct light over the horizon (except for signs on light boxes where this is not possible). The neon lights will be used as indirect lighting (projecting light onto the wall or floor) avoiding the light on the horizon or in light boxes. In no case is indirect lighting reflected on mirror-type surfaces or with a reflection of more than 40%.

In illuminated advertisements it is possible to use low-pressure lamps (neons, fluorescents, low-pressure sodium) and LEDs. The **use of high-pressure discharge lamps (sodium, mercury, halides)** is prohibited.

The lighting levels will not exceed those specified for the E1-E2 zones indicated in the ITC-EA-03 table 3 of RD.1890/2008 (see Summary of Recommendations on the IAC website), considering **E1 La Palma and the rural or open field areas of Tenerife, with a maximum point (spot) brightness of 50cd/m<sup>2</sup>, and E1/E2 the urban areas of Tenerife on the façade, on the first floor or under the cornice, in this case the maximum spot brightness is 200cd/m<sup>2</sup>.**

In signs illuminated with projectors (usually warm LEDs, compact or linear fluorescence or small incandescent lamps) it will be illuminated from top to bottom preventing the light source from projecting the light outside the sign and over the horizon (this aspect must also be considered in its design towards the opposite side to be illuminated). The "garden skewer" criterion could be used with the outflow formula for 40 lux. (For example, small warm LED spotlights with 450lm interspaced every 2.5m can be used on the sign, illuminated towards the sign but without projecting light towards the back of the sign).

In signs with letters illuminated indirectly (hidden light source, recessed) by reflection of light on the wall, the same criterion of lighting levels (or brightness) will be used, in this case the surface to be considered being the contour of the illuminated wall behind the letter or logo (medium level where the minimum/maximum point >1/10).

On **LED signs or screens**, with direct light from LED arrays: they must have a **time control of the brightness** so that from sunset (50 lux outdoors) it does not exceed the maximum brightness indicated for zone E1 and E1/E2. The **aperture of the main beam**

of the LEDs will be **less than 30°** (ideal 8°) and the **panel** (or the vertical faces that project light) must have a slight **inclination of at least 5° towards the ground**.

For the brightness regulation of LED screens used during the day with high brightness (2000-6000 cd/m<sup>2</sup>) they must have a system that detects sunset and its subsequent shutdown at 11:45 p.m. until dawn. The use of astronomical switches (as an external control element or using an algorithm in the system's control program by means of a table of annual sunset schedules) or by means of a photoelectric cell (set to <50 lux) is recommended. In any case, the system must be acquired with this capacity.

Posters (light boxes) with fluorescent lights or LEDs inside (**not recommended**) must have an opaque or very slightly lit background (<25% of the maximum brightness) and show the drawings or illuminated letters (light output by texts and drawings). Exceptionally, if the illuminated surface of the background is smaller than that of the screen print, it will be decided to illuminate the background and limit that of the screen printing. The maximum permissible spot brightness must not be exceeded anywhere on the sign.

**In zone E1**, in order not to exceed 50cd/m<sup>2</sup>, the light boxes may have the light pipes (a single linear tube, not overlapping) at the top of the sign inside an opaque box ("U" open towards the floor) or a reflector, so that the light goes downwards and not directly to the front or panels of the sign, also limiting translucent surfaces or white backgrounds to less than 50%. This type of poster will not be placed in **ZAS areas**.

A very suitable and **recommended** case of sign is the one that uses fluorescent tubes arranged in ceiling recessed luminaires arranged at the top of the sign so that all the light is projected onto the floor and sign (without direct light emission on the horizon):

(It has the advantage of limiting glare, illuminating the perimeter under the sign and allowing better visibility of the interior of the establishment from the outside when installed on the façade).



They shall have the following concentrations of luminous flux per linear metre of sign and proportional in height up to 1m (for more than 1m use the maximum density indicated for 1m) (without exceeding the levels or brightness established in the standards or published in the Summary of Recommendations):

- Fluorescent, neon: 2000 Lumens/m/ 1m height (single linear tube, no overlap)
- LED strips with concentrator optics: 250 lumens outgoing in-line/m/1m height (500lm/m if it is plate flow with opal diffuser). Unconcentrated LED strips (120°): 500 linear lm/m/1m height.

The lamps should try to have warm light or a color temperature < 2700°K (blue peak > 440nm and null < 380nm).

It is recommended that the systems be dimmable to setup the right brightness.

In any case, they will be switched off before midnight or before the closing of the establishment. If the justified closure (to indicate open establishment) is after 24 hours, the recommended signs may be used, but the lumens/m.l. indicated, or brightness, will be reduced by at least half and not exceeding 50 cd/m<sup>2</sup>, and of small dimensions with a wingspan of less than 15 cm (for example, with letters "OPEN") and is not applicable to **high sensitivity areas (ZAS)** (in these ZAS zones, the possibility of using yellow/orange light sources or between 575-625 nm would be studied).

## **Documentation to be submitted for the issuance of technical reports**

Location plan, plan of dimensions of the sign, square meters, type of luminaires or projectors used, number of luminaires or lighting systems, type, power, lumens and number of lamps used (or neon meters), distribution of lamps on the sign, time operation and system that guarantees this operation. In the light boxes, a plan or sketch must also be provided with the materials used, distribution of the light sources and the approximate calculation of brightness (see document Summary of recommendations for the lighting of Outdoor Installations or in Open Spaces on the IAC website [www.iac.es/otpc/documentos](http://www.iac.es/otpc/documentos)).

In the case of using projectors in exhibitions, the type (according to the list of examples of projectors published on the IAC website), installation height, physical inclination of the projector and required range (distance between the base of the pole and the limit of the area to be illuminated) must be indicated. The corresponding complete lighting calculation and justification of compliance with technical specifications for street lighting or large areas must be attached (the photometric file will be provided to the OTPC).

For signs illuminated with projectors: sketch of the arrangement of the projectors and the sign where the light control over the horizon is observed (It should be noted that, for example, a simple symmetrical projector tilted 30° towards the sign and placed above the sign should have a visor when projecting light on the horizon towards the back of the sign). The use of lighting levels for dark surfaces must be justified (see summary document of recommendations for lighting in Outdoor Installations or Open Spaces on the IAC website [www.iac.es/otpc/documentos](http://www.iac.es/otpc/documentos)) (normally designed for 150 lux).

In the case of using LEDs, it must also provide a technical sheet indicating lumens, power consumed and color temperature. If they are strips, the lumens per linear meter (specify protrusions or installed) and installed meters and if they are concentrated projectors provide the photometry and complete lighting calculations.

## **Articles on which these technical specifications have been based**

Article 2 of Law 31/88 and Articles 4, 6, 7 and 14 of RD 243/92.

## LA PALMA AND TENERIFE

### C-3) LIGHTING OF SPORTS AND RECREATIONAL FACILITIES

**Lamps:** all.

**Switched off before or no later than 12 noon (see section G-6).**

**Luminaires:** that prevent the emission of light outside the area of action, especially in the open sky and in directions close to the horizon:  **$U \geq 50\%$** .

The use of light cannons, luminaires projecting light on the horizon or lasers for advertising, recreational or cultural purposes is prohibited.

#### General considerations:

Any lamp. Switched off from 12 noon at night with an automatic system not accessible by unauthorized personnel, acting on any manual control, and an indelible sign easily visible on the control panel indicating the obligation to switch it off. They will be installed **Projectors with asymmetrical front-facing optics suitable for the height of the projector and the area to be illuminated.** The point or angle of reach will be determined approximately as follows: angle of reach = angle of asymmetry + inclination  $\approx$  arctangent [Length to be illuminated in front of the projector/ Installation height]

**The front throw angle will never be greater than 70°, that is, a distance "D" can never be illuminated from the projector more than 3 times the installation height "h", and the intensity above 85° will be less than 50cd/klm and at 90° < 10cd/klm, quickly cancelling out these reference angles.**

Projectors that do not comply with the previous paragraph will not be admitted, nor will installations whose projectors do not have the minimum range necessary to adequately illuminate the areas furthest from the installation in accordance with the above formula. The photometric matrix of the projector must be provided for study (with sufficient precision to allow intensities of 50 cd/klm and 10cd/klm).

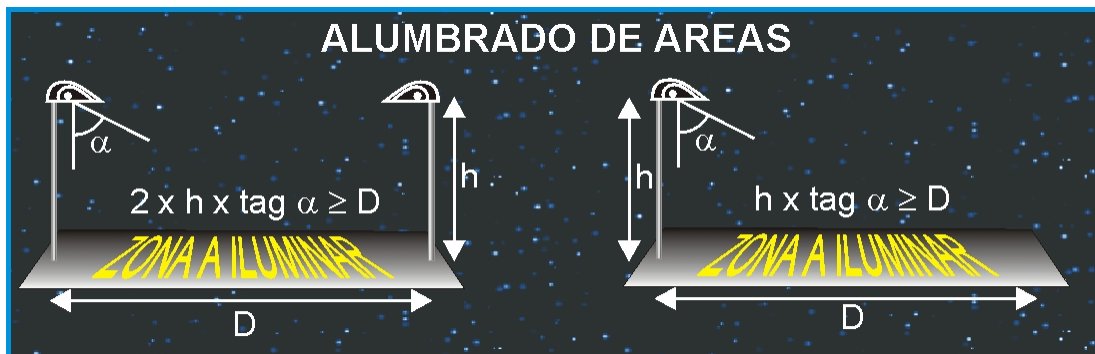

Projects must have detailed information on the projector's optics, the location, pointing and inclination of the projectors. The chosen level must be justified (see summary of recommended lighting levels on the IAC website) and the lighting calculation of the installation must be attached, including all the starting data, layout coordinates, orientation and pointing, calculation area and calculation of the utility (utilance) (**U**) (total maintenance factor  $\geq 0.8$ ).

**The design will be such that a  $U \geq 50\%$  is obtained**

The minimum lighting levels **maintained in accordance with UNE-EN 12193** shall not be exceeded by more than 20%.

Designs with lighting levels higher than the training level must be justified with a certificate issued by the corresponding city council or federation with the type or level of competition envisaged. In these cases, it must have ignitions that allow only the training lighting to be selected.

## LA PALMA AND TENERIFE

### C-4) LIGHTING OF FESTIVE FACILITIES

The use of light cannons, luminaires projecting light on the horizon or lasers for advertising, recreational or cultural purposes is prohibited.

These facilities must normally be switched off before or from 11:45 p.m. until dawn, except on specially designated days (large influx of public) when they justifiably comply with the procedure described in sections 13 and 28.2 of R.D. 243/92.

It is also limited in power density according to ITC-EA-02.7 of RD.1890/2008.

#### **Luminous Ornaments:**

Decorations or light motifs **must not exceed 156 lm/m installed or 50 lm/m for protruding lumens**. Following this criterion, it is recommended:

- 1) Luminous wires formed by a hose with tiny bulbs (150lm/m) with a consumption per reason between 50w – 100w. They should avoid blue light or spectral radiances below 500nm. (Usually 15lm/W incandescent or 50-80lm/W warm LEDs).
- 2) Incandescent (Christmas) fireflies (15lm/w) made up of small bulbs of about 0.3W each with approximately 90W per ornament or motif (about 33 bulbs/m).

The use of garlands of incandescent bulbs or LEDs is restricted to powers not exceeding **150 lumens** (15w in incandescence and  $\approx 1.5w$  in LED) and **remain off from 12 noon** at night. The use of this type of bulbs can be recommended for the case of Christmas decorations of leafy trees (placing the bulbs every more than 0.8m), where the bulb acts as a Christmas ball (preferably use LED of [100-200 lm] 1-2w warm light, 2700°K without ultraviolet (null < 380nm) and blue peak > 440nm, in the shape of a bulb).

#### **Projectors:**

The projectors will avoid direct light on the horizon. Asymmetrical projectors that meet this requirement (without tilting) should be used. For all purposes, they must be installed with the same technical specifications as sports and recreational lighting, C-3. Efforts should be made to use VSBP and VSAP lamps or IAC Amber and IAC Pure Amber LEDs. The use of white light after midnight is generally prohibited, unless the lamp or LED is certified by the IAC (see list of lamps/luminaires certified by the IAC on its website [www.iac.es/otpc/documentos](http://www.iac.es/otpc/documentos)), complying with article 7 of R.D. 243/92 in the case of discharge lamps and for white LEDs that comply with the specifications of section G-8.

The average levels for these occasions are very diverse, but the average 25 lux (class C1A) to the maximum of 30 lux (class C1) and exceptionally 50 lux for large crowds of people (outdoor shows, mass concerts) in brightly lit environments (class C0) are considered normal.

### DOCUMENTATION TO BE SUBMITTED FOR THE ISSUANCE OF TECHNICAL REPORTS

Location plan, floor layout plan, type of luminaires or projectors used, number of luminaires or lighting systems, type, power and number of lamps used (or metres of wire), technical data sheet of lamps and luminaires, **timetable operation** and system that guarantees this operation, **dates and times of starting/switching on and their dismantling**.

In the case of using projectors, the type, photometric matrix (with a minimum resolution of 10cd/klm), installation height, physical inclination of the projector and required range (distance between the base of the pole and the limit of the area to be illuminated) must be indicated, using the same technical specifications as sports lighting, with its corresponding calculation justifying lighting. For use after 24 hours, lamps or light sources certified by IAC (warm light) or VSAP or VSBP must be used.

## ANNEXES:

- A. LIGHTING CRITERIA WITH SPECIAL-USE LUMINAIRES.
- B. MINIMUM DOCUMENTATION TO BE INCLUDED IN TECHNICAL PROJECTS.
- C. STANDARD SHEET FOR ROAD-PEDESTRIAN LIGHTING
- D. PRACTICAL GUIDE TO LIGHTING LEVELS ACCORDING TO **EN-13201** and **RD.1890/2008**. **Summary: consult [www.iac.es/otpc/documents](http://www.iac.es/otpc/documents).**
- E. DESCRIPTION OF THE INFRACTIONS OR DEFICIENCIES AND THEIR CLASSIFICATION.

ANNEX - A

"LIGHTING CRITERIA WITH SPECIAL-USE LUMINAIRES"

INDEX

**0 - PURPOSE OF THIS CRITERION ..... 33**  
**1 - ZONES FOR SPECIAL-USE LUMINAIRES ..... 33**  
**2 - DEFINITION OF SPECIAL USE LUMINAIRE, TYPES AND DESIGN CRITERIA ..... 33**  
**3 - CRITERIA IN EXCEPTED AND EXTINGUISHED AREAS..... 35**  
**4- SYSTEM AND GUARANTEES OF SHUTDOWNS..... 35**  
**5- DOCUMENTATION TO BE SUBMITTED FOR THE ISSUANCE OF TECHNICAL REPORTS36**  
**6- CASES IN WHICH THE PHOTOMETRY OF THE LUMINAIRES IS UNKNOWN:..... 37**  
**7- GRAPHIC EXAMPLES..... 39**

## 0 - PURPOSE OF THIS CRITERION

This criterion is designed for small urban actions (squares, gardens, promenades, private homes) to allow a greater variety of luminaire models for the correct artistic integration of lighting in this type of unique installations, through the use of more flexible criteria in the evaluation of the influence on Astronomical Quality, in areas of lower sensitivity, but reducing their impact by using lamps with low luminous packages, low-height installation, low color temperature (low blue-ultraviolet radiation) and limiting the luminous power density (minimum interdistance).

In this sense, criteria are used to avoid the emission of light over the horizon (Art. 2 of Law 31/88), to use lamps with low ultraviolet radiation (Art. 7 of R.D. 243/92), to exclude from this use lighting that is not pedestrian, residential or garden (Art. 8, 9 and 10 RD 243/92) and so that its impact is minimal (Art. 6 RD243/92). Facilities that must be switched off after 24 hours will be considered exclusively ornamental, garden or recreational (Art. 12 and 13 of RD 243/92).

To avoid blue and ultraviolet radiation, the use of lamps with a color temperature above 2,700°K is limited, so lamps with a warm white color above 2700°K (or any °K with ultraviolet emission, < 380nm, or blue peak < 440nm) are prohibited.

The power and spacing limits are based on theoretical calculations and empirical data (mainly in hotel promenades and gardens and public promenades) so that adequate lighting can be guaranteed with Special Use luminaires if rational design criteria are used and with minimal light emission over the open horizon.

## 1 - ZONES FOR SPECIAL-USE LUMINAIRES

Special-use luminaires may be used in the following areas and types of lighting:

- Tenerife: Gardens, pedestrian walkways in urban areas and outside of homes, except for installations above 1000 m in height. Special Use Luminaires **type A and B**, except for unscreened places (buildings) which will be **type A**. Levels according to the corresponding type of lighting.
- All of La Palma and Tenerife over 1,000 m: Gardens, pedestrian walkways in urban areas and outside homes, except for installations in highly sensitive areas. Type A Special Use Luminaires. Levels according to the corresponding lighting class and **after midnight class P4 or lower**.
- See section on criteria in excepted areas (section 3).
- **NOTE:** In private housing estates with mixed pedestrian roads and vehicle accesses, as well as on access ramps to vehicle garages, this criterion may be used as long as they are **type A**.

## 2 - DEFINITION OF SPECIAL USE LUMINAIRE, TYPES AND DESIGN CRITERIA

Special Use luminaires are considered to be those with a reduced flux emitted towards their upper hemisphere (approximately <05%FHSint), with a beam of light mainly directed at the ground, avoid the emission of direct light towards the sky, their utilisation is greater than 50% and meet the following criteria:

- All surfaces of the luminaire with an outgoing light flux whose normal has an angle on the horizontal plane (floor) equal to or greater than 0° (zero degrees) must be obscured internally or externally. (Example: opaque upper hemisphere of balloons). The lower surfaces (not flat or not fully embedded) that refract light towards the upper hemisphere

must be transparent, smooth (Example: lower hemisphere of balloons) or opaline, without protruding more than 1cm below the opaque area.

- The lamps (bulbs) will be installed within the opaque surfaces and/or ceilings of the luminaire, so that they are wrapped in its upper hemisphere (within said opaque surfaces).
- The **installation height** will not exceed **2 m**. For light sources with a color temperature below 2,200°K, it can be installed up to 3 m high.
- **For average values of 10 lux**, the minimum distance in meters between luminaires or simple light points, is obtained by multiplying the total flux (lumens) of the luminaire by two and dividing by 100 ( $\pm 20\%$ ). For other illuminance values, it will be proportional (for 5 lux it would be twice the minimum distance than for 10 lux). These distances may be increased by means of lighting calculations according to the corresponding lighting class (but not reduced). The **maximum** output (useful) power will not exceed **450 lumens**. The maximum point illuminance in the installation must not exceed 10 times the level of the corresponding lighting class (provide photometry and isocandela diagram). If photometry is not available, the formula with factors indicated in the corresponding section will be used.
- **Flow reduction: a flow reduction of up to 50% will be expected at 24 hours, with alternating shutdown of the installation or homogeneously (up to at least class S4 or the class that is justified for that hour).**

### Types of Special Use and Signaling Luminaires:

**Special Use Type A:  $FHS < 1\%$ .** They are those in which the luminaires do not have direct apparent emission or in plain sight over the horizon. This can be verified by a simple visual inspection with the observer in any area in or on the horizontal plane that passes under the luminaire in its installation position, the observer will not be able to see the lamp lit or reflected or refracted light at any time. For example, it would be the case of beacons with matte black slats overlapped at  $45^\circ$  towards the ground or device with a flat glass closure (this would not be the case of a simple lantern or wall lamp with a transparent inclined vertical closure, or a beacon with a semi-dark lower inclined plane on which it projects the light).

**Special Use Type B:  $FHS < 5\%$ .** These are those in which the diffuser protrudes slightly from the opaque area (e.g.: lamp recessed in a lantern-type luminaire with a smooth transparent inclined vertical closure or beacon with a lower ramp under the light output of semi-dark matte color, or beacon with an opaline diffuser that protrudes less than 1 cm. below the light output, or with an opaline flat closure between up to  $30^\circ$  of inclination).

The light output above the horizon will be zero at  $45^\circ$  and its light emission will be mainly directed downwards (see examples in section 8).

For the use of **type B luminaires**, the existence of obstacles in front, around or on the luminaire with a height such that the imaginary line between the lamp and the upper end of the obstacle forms an angle equal to or greater than  $45^\circ$  on the horizontal plane passing through the lamp shall be justified.



**Safety signage:** For signage ( $\approx 50\text{mm}$ ), if they do not meet the Special Use criteria, colors between red and yellow should be used, between 575-625nm (not green, blue or white) with less than 10 lumens ( $\approx 0.1\text{w}$  in LEDs) or less than  $50\text{cd}/\text{m}^2$ . On stairs it can be used recessed in the riser with an opal diffuser or with optics with visors that direct the light to the ground. Maximum 10 lumens/meter of step or interdistance.

**Environments of buildings with activity open to the public:** those outdoor spaces of buildings with activities that require a lighting level greater than 20 lux and less than 100 lux during their development (restaurant terraces, access to public services, entrance to shops, etc.), may use this criterion with type A luminaire and increase the maximum outflow limit in proportion to the excess over 20 lux (for example, for 50 lux up to  $450/20 \times 50 = 1125\text{ lm}$ ), until the end of the activity.

#### **NOTES on minimum distances:**

- a) The minimum distance will be maintained with any existing lighting, whether or not it is for special use, and in some cases the distance between luminaires must be increased or having to be turned off at 12 noon at night if there is sufficient other lighting to maintain safety levels (in the latter case it will be considered ornamental). For different types of luminaires and lamps, the minimum distance will be calculated using the lumen-weighted average obtained between each pair.
- b) In stairwell areas, the minimum distance may be reduced by half, according to the applicable regulations (normally 20 lux).
- c) Neither before nor after midnight may the interdistance be reduced by more than 20% of the calculated limit.

### **3 - CRITERIA IN EXCEPTED AND EXTINGUISHED AREAS**

In the **excepted areas** (high sensitivity area in La Palma), the luminaires for special use must remain switched off from 12 noon at night (those located less than 9km from the ORM) and in any case must meet the following criteria:

- 1) The luminaires will apparently not emit direct light on or over the horizon. Type A luminaires will be used.
- 2) Specific lighting levels 3 times higher than the expected average will be avoided, so it will be necessary to limit the installed power in some types of luminaires.
- 3) In any case, they will be switched off from midnight, except within consolidated urban centers designed from this time for class P5 or lower.

In the case of permanent lighting outside consolidated urban centers, the use of P5 lighting class and type A luminaires with amber or red lamps (between 575-625nm) with very low powers ( $< 450\text{ lumens}$ ) and in strictly necessary areas will be studied.

### **4- SYSTEM AND GUARANTEES OF SHUTDOWNS**

**The switch-offs planned** in any area must be carried out no later than **12 noon at night** and until dawn. This **will be guaranteed** by the use of time switches with a minimum power reserve of 100 hours and automatic time change, or similar device, programmed no later than 11:45 p.m. In hotels, or similar, with central control computers, these lights will be programmed in such a way as to give a warning in the event of non-compliance with Law 31/88 and the user book of the control unit must include at least the warning of compliance with 31/88 describing the specific actions (switch-offs, reductions, schedules).

Note: compliance with hourly shutdown, if applicable, must be designed and guaranteed for the life of the installation.

## **5- DOCUMENTATION TO BE SUBMITTED FOR THE ISSUANCE OF TECHNICAL REPORTS**

The **Project Report** or Technical Report must describe at least the following points:

- 1) Type of lighting (pedestrian, gardens, vehicle access, etc.) and classification of the land (Urban to be built, consolidated urban, etc.)
- 2) Description of the luminaires and their installation:
  - Lantern, beacon, bollard, signage, etc., indicating the type of diffuser (transparent, opaline, prismatic glass, black slats at 45° towards the ground, etc.), position of the lamp (vertical, horizontal), details relating to its light emission (lamp embedded in an opaque surface, not visible above the horizon, light projected downwards, etc.). Indicate type, model, manufacturer and accessories attaching a copy of the catalogue with **a photo** (It must be accompanied by a photometry of the luminaire and a diagram of isocandelas, which may be essential in some cases). A diagram of the section of the luminaire with the arrangement of the lamp inside it is usually very explanatory.
  - Installation height, spacing between light points, arrangement of luminaires (no inclination, recessed in vertical wall, etc.). Calculation and justification of the minimum interdistance.
- 3) Number of lamps per luminaire (usually one, the maximum power indicated in section 3 must not be exceeded).
- 4) Number of luminaires per light point (generally one, the maximum power indicated in section 3 must not be exceeded, except for some ornamental and independent beacons that will be switched off according to the Regulations, to be justified).
- 5) Number of light points of each class.
- 6) Type, model and power (lm and W) of the lamp(s) to be used in each luminaire, indicating model, manufacturer and color temperature (in the case of compact fluorescent lamps the power reference will be accompanied by the following numbering /x27, and in LEDs 2700K, or lower, without ultraviolet emission, null <380nm, or blue peak <440nm).
- 7) Describe the shutdown system, if necessary, and how its operation is guaranteed during the life of the installation. Shutdown operating hours.
- 8) Indicate that there is no other outdoor or open area lighting that contributes to the performance of the Project and that has not been mentioned in it.
- 9) Description of the obstacles in front of and on the luminaires if necessary (according to criteria).
- 10) Spectral radiance data from 380 to 780nm, if required, in paper and digital format (EXCEL). In general, 2,700°K in LED should not exceed 10% spectral radiance below 500nm and the ratio between maximum radiance of blue and maximum amber should be less than 0.4. The radiance below 380nm must be zero and the blue peak above 440nm.

The following Plans must be provided:

- 1) Location and site plan
- 2) Plan/s of distribution of luminaires in plan with scale. In these plans, the points of light will be identified with their different luminaires and lamps and installation heights. It will be indicated, where appropriate, **which remain on all night (TN) and which are turned off (MN)**.
- 3) In the case of discontinuous hourly operation, a **single-line electrical** plan showing **the shutdown and its guarantee system**.
- 4) In the event of having to justify the existence of obstacles around the luminaires, a detailed plan (elevation) of these with respect to the luminaires (not necessary if their arrangement with the other plans is clear).

The **Budget** (statement of measurements) shall include the number of light points installed with their respective models and types of lamps (including color temperature reference) and the switch-off device, if applicable.

## 6- CASES IN WHICH THE PHOTOMETRY OF THE LUMINAIRES IS UNKNOWN:

Luminaires designed on site or where it is impossible to know their photometry data and consequently their total outgoing flow.

### 6.1 - USE OF LAMPS IN SPECIAL USE LUMINAIRES WITHOUT PHOTOMETRY.

Lamps to be used with Special Use luminaires, NOMINAL POWER OF THE INSTALLED LIGHT SOURCE:

- Compact fluorescents up to  $\leq 1,200$  lumens (<20w) with a color temperature equal to or less than  $2,700^{\circ}\text{K}$  (range /827).
- Warm color LED lamps with  $\leq 2700^{\circ}\text{K}$  (without ultraviolet, null <380nm, and blue peak >440nm) and  $\leq 900$  lumens (<10w). The spacing formula for LEDs with direct light will be used **by multiplying** the flux by a factor of **1.5**.
- For signaling lighting that does not meet Special Use criteria, refer to the section on the type of luminaires.
- For higher lamp powers, the normal criteria must be followed with certified luminaire and lamp by IAC.

### 6.2 – SPACING CALCULATIONS AND FACTORS APPLICABLE TO THE FLUX INSTALLED IN SPECIAL-PURPOSE LUMINAIRES

- **For average values of 10 lux**, the minimum distance in meters between luminaires or simple points of light is obtained by dividing by 100 the lumens installed in each luminaire ( $\pm 20\%$ ) multiplied by the maintenance (0.8) and efficiency factors indicated in the table of this document. For other illuminance values, the procedure will be proportional (for 5 lux it would be twice the minimum distance than for 10 lux). These distances may be increased by means of lighting calculations according to the corresponding type of lighting (but not reduced).

#### FACTORS APPLICABLE TO THE FLUX INSTALLED IN SPECIAL-PURPOSE LUMINAIRES:

For the purposes of calculating the minimum spacing, the following two factors (cumulative) may be applied to the nominal flow of the lamp indicated in the manufacturer's catalogue (only in cases where its performance is not known,  $\eta$ ):

- 1) Due to depreciation of the maintained flow:                      of                      1.0 to 0.8
- 2) By luminaire efficiency:    of                      1.0 to 0.5

Indicative examples of efficiency factors:

GUY	LUMINAIRE – BEACON/BOLLARD	FACTOR
B	Lantern lamp recessed in opaque top, smooth transparent closures	0,7
B	Beacon with flat opaline closure inclined at less than 30° (ceiling lamp)	0,9
B	Flat glass beacon and sloping lower surface in dark matt colour or with dark matt slats overlapping at 45°	0,8
B	Beacon with opal domed lower diffuser protruding less than 1cm Lamp recessed in opaque top.	0,9
To	IAC certified luminaire or similar without bottom housing	0,8
To	IAC-certified luminaire with matt dark underhousing (lantern)	0,6
To	Flat glass beacon and slanted lower surface matte black color	0,8
To	Beacon with vertical glass diffuser and matte black slats overlapped at 45°	0,5

For example: a lighthouse/bollard recessed in the wall at a height of 0.5 m with overlapping slats at 45° matt black directing the light towards the ground and with a compact fluorescent lamp of 15w/827 with an installed flux according to the manufacturer of 900 lumens. The minimum spacing for 5 lux will be as follows:  $D = 900 \times 0.8 \times 0.5 / 100 \times 10/5 = 7.2$  m. The minimum distance will be equal to or greater than 7.2m ±20% (minimum of 5.8 m). (Same result if the outflow were 180 lm with η=20%)

## 7- GRAPHIC EXAMPLES

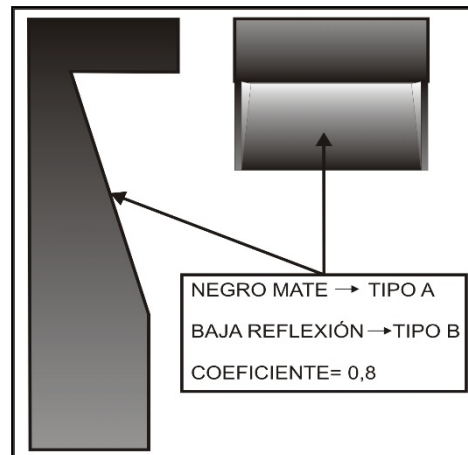
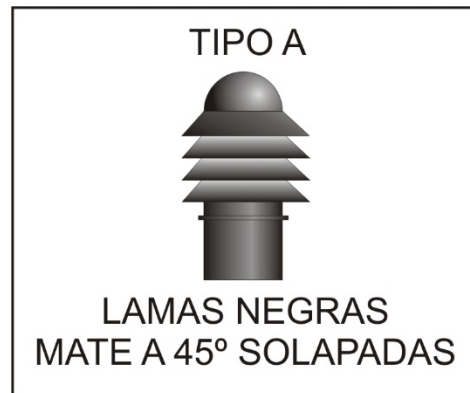
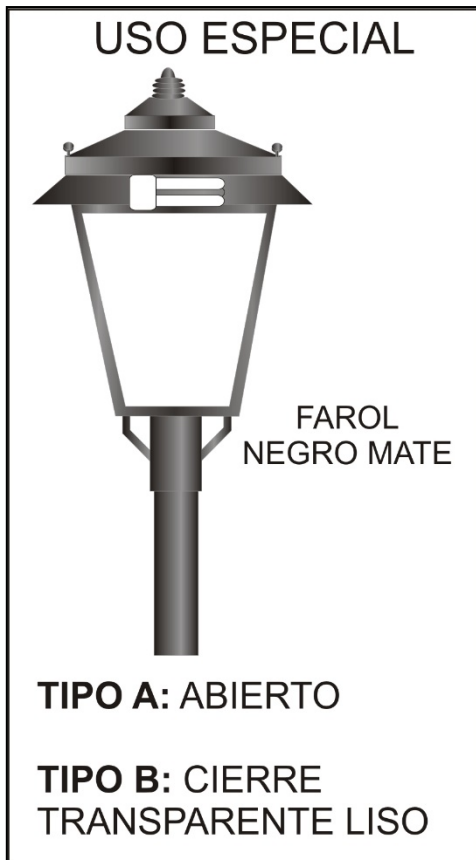
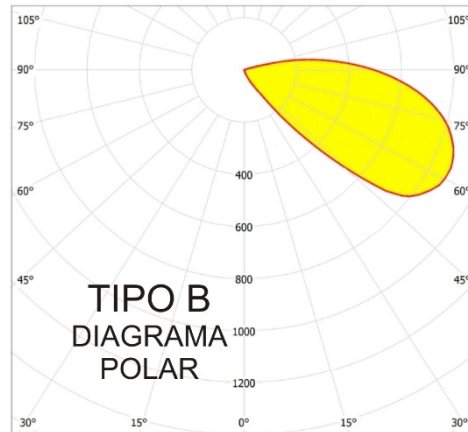
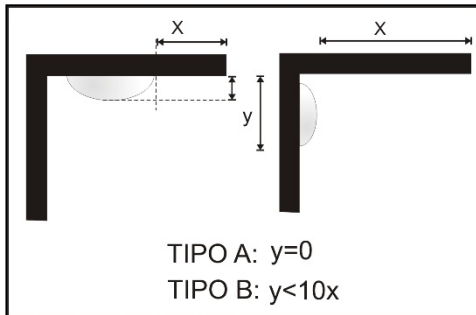
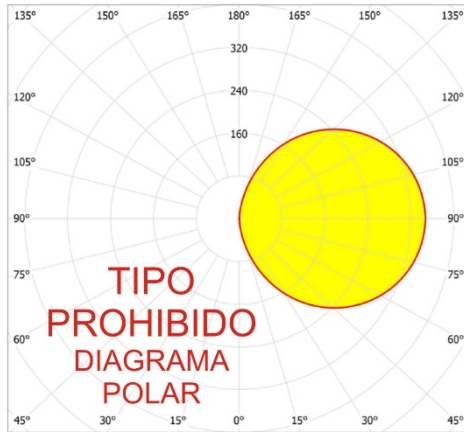
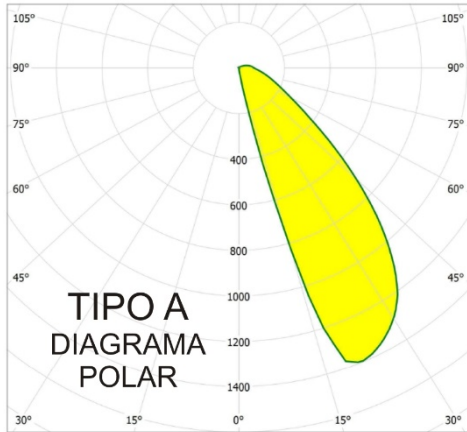

**EXAMPLES OF SPECIAL USE:**



**SAFETY SIGNAGE:**

**Special Use:**



**No Special Use but Red (575-625nm, <10 lm):**



**THEY DO NOT MEET SPECIAL USE:**



## ANNEX - B

### MINIMUM DOCUMENTATION TO BE INCLUDED IN PROJECTS FOR OUTDOOR LIGHTING INSTALLATIONS IN PROTECTED AREAS FOR THEIR EVALUATION WITH RESPECT TO LIGHT POLLUTION.

- Location and location plan indicating the height of the installation with respect to sea level.
- Description, if applicable, of natural or artificial obstacles (ZUA): in Tenerife with respect to the Island of La Palma and in La Palma respect of the Roque de los Muchachos area.  
In the case of La Palma, the horizontal distance to Roque de los Muchachos will also be indicated.
- Classification of facilities: Roads (type of roads), pedestrian, ornamental, sports, illuminated signs, etc., justified according to Regulations (RD.1890/2008) and IAC notebooks.
- Description of the devices used, indicating their operation: luminaires (classification according to the IAC, distribution, mounting position (inclination), distribution coordinates, mounting height, etc.), type of lamps, flow reduction and control devices (programming data), measures to ensure the switching off and/or flow reduction schedule, electrical single-line plane with the reduction or switching off devices, design sketch of visors and grilles, etc.
- Projected lighting levels before and after switching off or reducing, attaching the calculations made and justifying levels higher than those recommended before midnight and the recommended minimums after midnight. *The calculations must provide data on the distribution, height and pointing coordinates as well as the surface area of the calculated area and the utility (utilance) factor (U). It is recommended to provide a calculation file.*
- Sketch of luminaires and photo with mounting arrangement. In the case of luminaires certified by the IAC, it will be indicated that they have a five-year warranty according to the IAC's certification conditions, describing the method and period of maintenance of the luminaires indicated in the warranty. In the case of Special Use, photo of the luminaire and isocandela diagram and/or LDT photometry.
- The documents required in the specific sections of this notebook.



## ANNEX - C

### STANDARD SHEET FOR MOTORIZED AND PEDESTRIAN ROAD LIGHTING

#### A- INSTALLATION TYPE

Summary description of the type of road, dimensions, environment and distribution.

#### FLOW REDUCER: (0)

#### 1) INSTALLATION CLASSIFICATION: (1)

ZONE TYPE (2)	PROJECT STATUS: (3)	CLASS RD1890/2008: (4)
---------------	---------------------	------------------------

#### 2) TRACK DATA:

TOTAL WIDTH:	ROAD WIDTH/S:	SIDEWALK WIDTH/S:
MEDIUM WIDTH:	PARKING WIDTH/S:	ENVIRONMENT:

#### 3) LUMINAIRE DATA:

MAKER:	MODEL:	LAMP:	UNITS:
TYPE OF CLOSURE:	CERTIFICATE. IAC:	CERTIFICATE. IAC:	YIELD:

Indicate programming of electronic equipment, flow obtained, before and after the flow reduction at 11:45 p.m.

#### 4) LIGHTING INSTALLATION DATA:

DISTRIBUTION (5)	HEIGHT	INTERDISTANCE	INCLINATION	OPTICAL OVERHANG ON ROADWAY
------------------	--------	---------------	-------------	-----------------------------

#### 5) LIGHTING RESULTS:

The lighting levels after (and before) midnight (Illuminance) are as follows (coef. deprec. 0.8):

DISTRIBUTION	BEFORE (AVG//MAXIMUM//MINIMUM) - overall	Um	EU	AFTER (AVERAGE/MAXIMUM/MINIMUM)	Or:
(6)	(7) - (12)	(8)	(9)	(10)	(11)

In the event that there are several types of streets, distributions, luminaires, etc., a file will be made for each of them

- (0) Indicate if there is a flow reducer, type, schedule, guarantees (time reserve, automatic time change, autonomous operation according to the duration of the ignition), percentage of reduction and operation.
- (1) Type of road and use according to RD 1890/08 (see table Levels and summary of recommendations).
- (2) Location of the Facility (Urban, Suburban, Rural, Pedestrian, etc.)
- (3) Project situation according to RD 1890/08 (A1, A2, B1, D, E, sports, port, work area, security, etc.)
- (4) Class according to RD 1890/08 (C1, C4, P1, etc.) or other applicable standards.
- (5) Unilateral, bilateral, staggered, etc.
- (6) Calculation area, usually road. On roads with side carriageway and parking, the calculation of the carriageway and parking can be considered together.
- (7) Summary of the data obtained in the calculation before midnight (MED//MAX//MIN - Global)
- (8) Minimum Illuminance/Medium Illuminance (Medium Uniformity)
- (9) Minimum Illuminance/Maximum Illuminance (Extreme Uniformity)
- (10) Summary of data obtained in the calculation after midnight (reduced)
- (11) Utilance  $U = \text{Calculation surface} \times \text{maintenance-free average illuminance} / \text{protruding lumens of the luminaire-s used in that area}$ .  $U = fu / \eta$  ( $\eta = \text{luminaire performance}$ ) ( $U > 50\%$ , or 75%)

(12) Global: average illuminance obtained in the area with total useful width for the calculation of the usefulness (includes road/promenade, sidewalks, surroundings, etc.). See definition of global usable area in (G7).

ANNEX - D

PRACTICAL GUIDE TO LIGHTING LEVELS ACCORDING TO EN-13201 AND RD 1890/08

SITUACION DE PROYECTO	TIPO DE VÍA Y USO	CLASE / CRITERIOS	LUMINANCIA cd/m <sup>2</sup>			LUMINANCIA lux				
			MEDIA	MAX	U <sub>0</sub>	CLASE	MEDIA	MAX	Um	
A1	AUTOPISTAS Y AUTOVIAS.	M1	IMD > 25,000 (≥ 3 intersecciones*/km)	2	3	≥ 0,4	C1	30	72	≥ 0,4
		M2	IMD > 25,000 (< 3 intersecciones*/km)	1,5	2,3	≥ 0,4	C2	20	48	≥ 0,4
		M2	IMD > 15,000 (< 25,000 (≥ 3 intersecciones*/km))	1,5	2,3	≥ 0,4	C2	20	48	≥ 0,4
		M3	IMD < 25,000 (< 3 intersecciones*/km)	1	1,5	≥ 0,4	C3	15	36	≥ 0,4
		M3	IMD < 15,000	1	1,5	≥ 0,4	C3	15	36	≥ 0,4
		M1	IMD > 25,000	2	3	≥ 0,4	C1	30	72	≥ 0,4
A1	CARRETERAS UNICA CALZADA, DOBLE SENTIDO, VIAS RAPIDAS.	M2	IMD > 15,000 (< 25,000 (< 3 intersecciones*/km))	1,5	2,3	≥ 0,4	C2	20	48	≥ 0,4
		M2	IMD > 15,000 (≥ 3 intersecciones*/km)	1,5	2,3	≥ 0,4	C2	20	48	≥ 0,4
		M3	IMD < 15,000 (< 3 intersecciones*/km)	1	1,5	≥ 0,4	C3	15	36	≥ 0,4
		M2	IMD > 7,000 (< 3 intersecciones*/km)	1,5	2,3	≥ 0,4	C2	20	48	≥ 0,4
		M2	IMD > 7,000 (≥ 3 intersecciones*/km)	1,5	2,3	≥ 0,4	C2	20	48	≥ 0,4
		M3	IMD > 7,000 (< 3 intersecciones*/km)	1	1,5	≥ 0,4	C3	15	36	≥ 0,4
A2	CARRETERAS SIN ACERAS, CARRETERAS RURALES.	M3	IMD < 7,000 (≥ 3 intersecciones*/km)	1	1,5	≥ 0,4	C3	15	36	≥ 0,4
		M4	IMD < 7,000 (poco tránsito)	0,75	1,1	≥ 0,4	C4	10	24	≥ 0,4
		M1	IMD > 25,000 (≥ 3 intersecciones*/km)	2	3	≥ 0,4	C1	30	72	≥ 0,4
		M2	IMD > 25,000 (< 3 intersecciones*/km)	1,5	2,3	≥ 0,4	C2	20	48	≥ 0,4
		M2	IMD > 15,000 y < 25,000	1,5	2,3	≥ 0,4	C2	20	48	≥ 0,4
		M3	IMD > 7,000 y < 15,000	1	1,5	≥ 0,4	C3	15	36	≥ 0,4
A3	CARRETERAS RAPIDAS EN CIUDADES, CIRCUNVALACIONES, RONDAS.	M4	IMD < 7,000	0,75	1,1	≥ 0,4	C4	10	24	≥ 0,4
		M2	IMD > 7,000 comercial/turístico	1,5	2,3	≥ 0,4	C2	20	48	≥ 0,4
		M3	IMD > 7,000	1	1,5	≥ 0,4	C3	15	36	≥ 0,4
		M4	IMD < 7,000	0,75	1,1	≥ 0,4	C4	10	24	≥ 0,4
		M3	IMD > 7,000	1	1,5	≥ 0,4	C3	15	36	≥ 0,4
		M6	Poco tránsito, sin estacionamientos	0,3	0,5	≥ 0,35	C5	7,5	18	≥ 0,4
B1	CALLES PRINCIPALES EN CIUDADES / ARTERIAS URBANAS.	M2	IMD > 7,000 comercial/turístico	1,5	2,3	≥ 0,4	C2	20	48	≥ 0,4
		M3	IMD > 7,000	1	1,5	≥ 0,4	C3	15	36	≥ 0,4
		M4	IMD < 7,000	0,75	1,1	≥ 0,4	C4	10	24	≥ 0,4
		M3	IMD > 7,000	1	1,5	≥ 0,4	C3	15	36	≥ 0,4
		M4	IMD < 7,000	0,75	1,1	≥ 0,4	C4	10	24	≥ 0,4
		M5	IMD < 4,000 poco tránsito	0,5	0,8	≥ 0,35	C5	7,5	18	≥ 0,4
B2	CAMINOS/CARRETERAS RURALES.	M6	Poco tránsito, sin estacionamientos	0,3	0,5	≥ 0,35	C5	7,5	18	≥ 0,4
		M6	Poco tránsito, sin estacionamientos	0,3	0,5	≥ 0,35	C5	7,5	18	≥ 0,4
		M6	Poco tránsito, sin estacionamientos	0,3	0,5	≥ 0,35	C5	7,5	18	≥ 0,4
		M6	Poco tránsito, sin estacionamientos	0,3	0,5	≥ 0,35	C5	7,5	18	≥ 0,4
		M6	Poco tránsito, sin estacionamientos	0,3	0,5	≥ 0,35	C5	7,5	18	≥ 0,4
		M6	Poco tránsito, sin estacionamientos	0,3	0,5	≥ 0,35	C5	7,5	18	≥ 0,4
D1/D2	AREAS DE APARCAMIENTOS, ESTACIONES DE GUAGUAS.	M6	Poco tránsito, sin estacionamientos	0,3	0,5	≥ 0,35	C5	7,5	18	≥ 0,4
		M6	Poco tránsito, sin estacionamientos	0,3	0,5	≥ 0,35	C5	7,5	18	≥ 0,4
		M6	Poco tránsito, sin estacionamientos	0,3	0,5	≥ 0,35	C5	7,5	18	≥ 0,4
		M6	Poco tránsito, sin estacionamientos	0,3	0,5	≥ 0,35	C5	7,5	18	≥ 0,4
		M6	Poco tránsito, sin estacionamientos	0,3	0,5	≥ 0,35	C5	7,5	18	≥ 0,4
		M6	Poco tránsito, sin estacionamientos	0,3	0,5	≥ 0,35	C5	7,5	18	≥ 0,4
D3/D4	CALLES RESIDENCIALES CON VEHICULOS Y CON ACERAS A LO LARGO DE LA CALZADA.	M6	Poco tránsito, sin estacionamientos	0,3	0,5	≥ 0,35	C5	7,5	18	≥ 0,4
		M6	Poco tránsito, sin estacionamientos	0,3	0,5	≥ 0,35	C5	7,5	18	≥ 0,4
		M6	Poco tránsito, sin estacionamientos	0,3	0,5	≥ 0,35	C5	7,5	18	≥ 0,4
		M6	Poco tránsito, sin estacionamientos	0,3	0,5	≥ 0,35	C5	7,5	18	≥ 0,4
		M6	Poco tránsito, sin estacionamientos	0,3	0,5	≥ 0,35	C5	7,5	18	≥ 0,4
		M6	Poco tránsito, sin estacionamientos	0,3	0,5	≥ 0,35	C5	7,5	18	≥ 0,4
E1/E2	PLAZAS URBANAS Y ZONAS PEATONALES.	M6	Poco tránsito, sin estacionamientos	0,3	0,5	≥ 0,35	C5	7,5	18	≥ 0,4
		M6	Poco tránsito, sin estacionamientos	0,3	0,5	≥ 0,35	C5	7,5	18	≥ 0,4
		M6	Poco tránsito, sin estacionamientos	0,3	0,5	≥ 0,35	C5	7,5	18	≥ 0,4
		M6	Poco tránsito, sin estacionamientos	0,3	0,5	≥ 0,35	C5	7,5	18	≥ 0,4
		M6	Poco tránsito, sin estacionamientos	0,3	0,5	≥ 0,35	C5	7,5	18	≥ 0,4
		M6	Poco tránsito, sin estacionamientos	0,3	0,5	≥ 0,35	C5	7,5	18	≥ 0,4
-	PASARELAS PEATONALES, ESCALERAS, RAMPAS, PASOS DE PEATONES	M6	Poco tránsito, sin estacionamientos	0,3	0,5	≥ 0,35	C5	7,5	18	≥ 0,4
		M6	Poco tránsito, sin estacionamientos	0,3	0,5	≥ 0,35	C5	7,5	18	≥ 0,4
		M6	Poco tránsito, sin estacionamientos	0,3	0,5	≥ 0,35	C5	7,5	18	≥ 0,4
		M6	Poco tránsito, sin estacionamientos	0,3	0,5	≥ 0,35	C5	7,5	18	≥ 0,4
		M6	Poco tránsito, sin estacionamientos	0,3	0,5	≥ 0,35	C5	7,5	18	≥ 0,4
		M6	Poco tránsito, sin estacionamientos	0,3	0,5	≥ 0,35	C5	7,5	18	≥ 0,4
-	VIGILANCIA/SEGURIDAD: INDUSTRIAS, COMERCIOS, INSTALACIONES DEPORTIVAS, ETC (SEGUN PELIGROSIDAD). (ITC-EA-02-5)	M6	Poco tránsito, sin estacionamientos	0,3	0,5	≥ 0,35	C5	7,5	18	≥ 0,4
		M6	Poco tránsito, sin estacionamientos	0,3	0,5	≥ 0,35	C5	7,5	18	≥ 0,4
		M6	Poco tránsito, sin estacionamientos	0,3	0,5	≥ 0,35	C5	7,5	18	≥ 0,4
		M6	Poco tránsito, sin estacionamientos	0,3	0,5	≥ 0,35	C5	7,5	18	≥ 0,4
		M6	Poco tránsito, sin estacionamientos	0,3	0,5	≥ 0,35	C5	7,5	18	≥ 0,4
		M6	Poco tránsito, sin estacionamientos	0,3	0,5	≥ 0,35	C5	7,5	18	≥ 0,4
-	PORTALES/ACCESOS A EDIFICIOS HASTA ZONA SEGURA RD314/2006 SUA 4.1, RESTO DE ZONAS RD.1890/2008	M6	Poco tránsito, sin estacionamientos	0,3	0,5	≥ 0,35	C5	7,5	18	≥ 0,4
		M6	Poco tránsito, sin estacionamientos	0,3	0,5	≥ 0,35	C5	7,5	18	≥ 0,4
		M6	Poco tránsito, sin estacionamientos	0,3	0,5	≥ 0,35	C5	7,5	18	≥ 0,4
		M6	Poco tránsito, sin estacionamientos	0,3	0,5	≥ 0,35	C5	7,5	18	≥ 0,4
		M6	Poco tránsito, sin estacionamientos	0,3	0,5	≥ 0,35	C5	7,5	18	≥ 0,4
		M6	Poco tránsito, sin estacionamientos	0,3	0,5	≥ 0,35	C5	7,5	18	≥ 0,4
E1/E2	SITUACIONES ESPECIALES EN LA PALMA DESPUES DE MEDIANOCHE LED AMBAR IAC (Uz75%)	M6	Poco tránsito, sin estacionamientos	0,3	0,5	≥ 0,35	C5	7,5	18	≥ 0,4
		M6	Poco tránsito, sin estacionamientos	0,3	0,5	≥ 0,35	C5	7,5	18	≥ 0,4
		M6	Poco tránsito, sin estacionamientos	0,3	0,5	≥ 0,35	C5	7,5	18	≥ 0,4
		M6	Poco tránsito, sin estacionamientos	0,3	0,5	≥ 0,35	C5	7,5	18	≥ 0,4
		M6	Poco tránsito, sin estacionamientos	0,3	0,5	≥ 0,35	C5	7,5	18	≥ 0,4
		M6	Poco tránsito, sin estacionamientos	0,3	0,5	≥ 0,35	C5	7,5	18	≥ 0,4

**NOTE:** Calculation of "U" on roads with a width of "a", on pedestrians it is calculated with a width of 2+a+2 meters and on roads a/2+a+a/2 m (a/2 ≤ 5m\*), if there are no obstacles or different property in their surroundings. If the environment is limited by walls, add 1m on that side per obstacle (1+x+w+x+1m) without exceeding the maximum width of the environment. Other parameters or situations see EN13201\* and RD.1890/08.



**ANNEX - E**

**DESCRIPTION OF VIOLATIONS OR DEFICIENCIES AND THEIR CLASSIFICATION**

Summary of the possible deficiencies of the facilities and assessment of their effect:

	<b>TYPE OF NON-COMPLIANCE</b>	<b>LAW 31/88</b>	<b>R.D. 243/92-580/17</b>	<b>R.D. 1890/2008 ITC EA-03</b>	<b>ITC EA---</b>
1	Improper use of projectors	Art. 2	Art. 6 and 8	Art 1.1	<b>04-Art 3.1</b>
2	Improper use of luminaires	Art. 2	Art. 6 and 8	Art 1.1	
3	Use of polluting luminaires	Art. 2	Art. 6 and 8	Art 1.1	
4	Excess levels or potency	Art. 2	Art. 6	Art 1.1 and 2	
5	Use of inappropriate lamps	Art. 2	Art. 6,7,9,10 y 14	Art 1.2	
6	No switch-offs and/or reduction at 24:00 h.	Art. 2	Art. 6,11,12, 13 y 14	RD. Art.8	<b>02-Art 9.</b>
7	No technical report (Art. 40.47 Law 39/2015)	Art. 5	Art. 28		

**The installation produces light pollution due to non-compliance with the technical requirements set by RD. 243/92 and the catalogue of technical specifications of the IAC, its sanctioning regime being that established by R.D. 1890/2008 (defects in bold):**

	<b>CLASSIFICATION OF DEFICIENCIES ITC EA-05 OF R.D. 1890/2008</b>	<b>2.4.1. VERY SERIOUS</b>	<b>2.4.2. SERIOUS</b>	<b>2.4.3. LIGHTWEIGHT</b>
a	Tenerife <1000m and facilities in general: Utilancia U ≥ 50% .....	At < 35%	35% ≤ U < 40%	40% ≤ or < 50%
	La Palma LED AMBER U > 75% straight spans .....	At < 53%	53% ≤ or < 60%	60% ≤ or < 75%
	La Palma LED AMBER U > 65% irregular sections. ....	U < 46%	46% ≤ or < 52%	52% ≤ or < 65%
b	Excess levels	+50%	+30%	+20% (15%)
c	Shutdown and/or reduction system	Not installed	Inadequate or Broken	Deficient
d	Failure to comply with shutdown/reduction schedules	Repeatedly	+10 times a year	+ 4 times a year
and	Overcome the installed FHS	+ 15% del %FHSinst	+ 8% del %FHSinst	+3% del %FHSinst
g	Recidivism and other defects	Serious Recidivism	Mild recidivism	Other
	<b>RADIANCE IN LAMPS</b>	White light outside the IAC's standard and cataloguing, in installation and/or schedule not allowed (Art. 6, 7, 9, 10, 12, 13 and 14 of RD. 243/92-580/17).	White light catalogued by the IAC or VSAP, in installation and/or hours not allowed (Art. 6, 7, 9, 10, 12, 13 and 14 of RD. 243/92-580/17).	